

MidtermCeliaWoessner

Scene	Duration	Panel	Duration
1	02:19	1	00:08

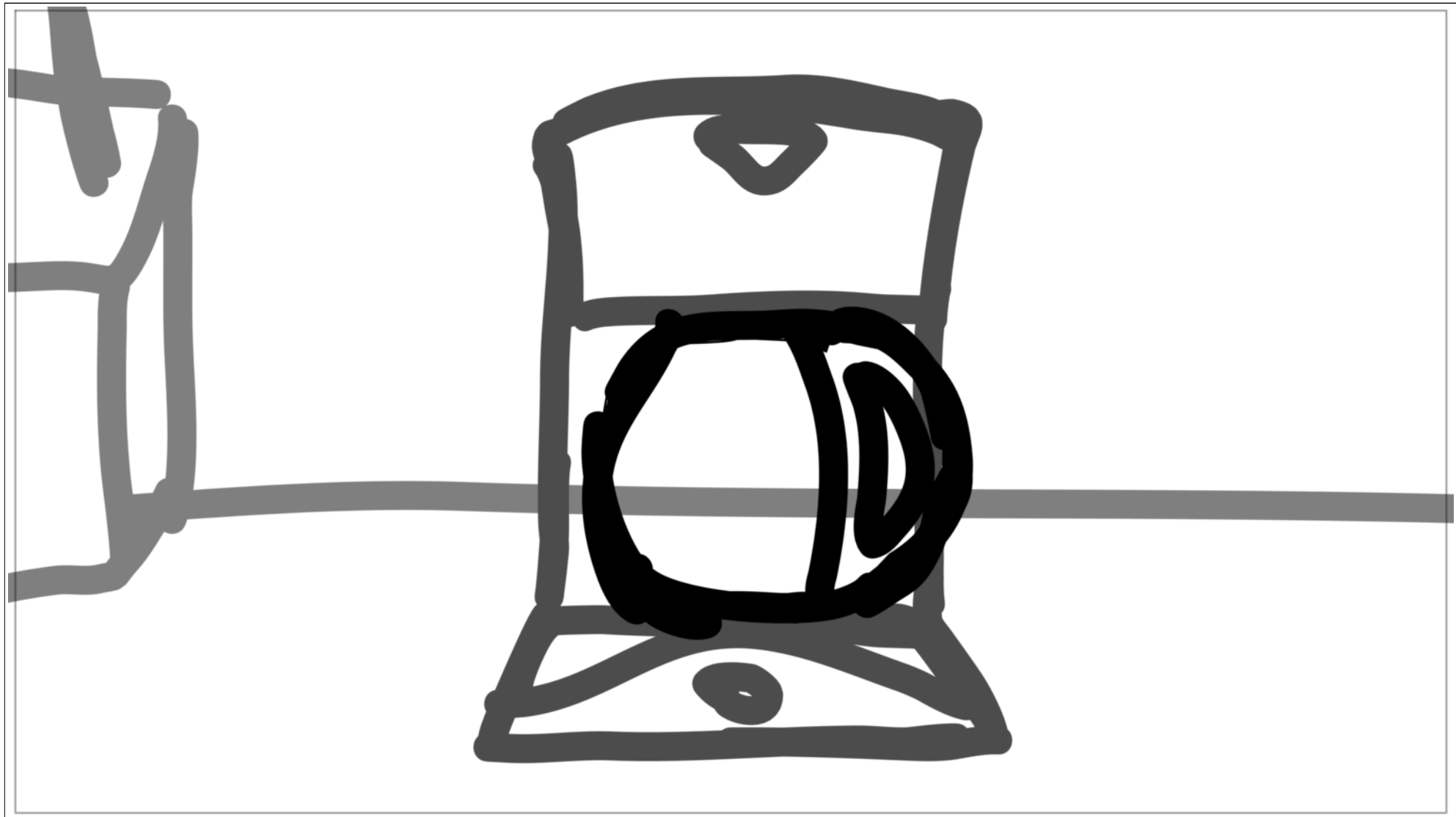

Scene	Duration	Panel	Duration
1	02:19	2	00:19

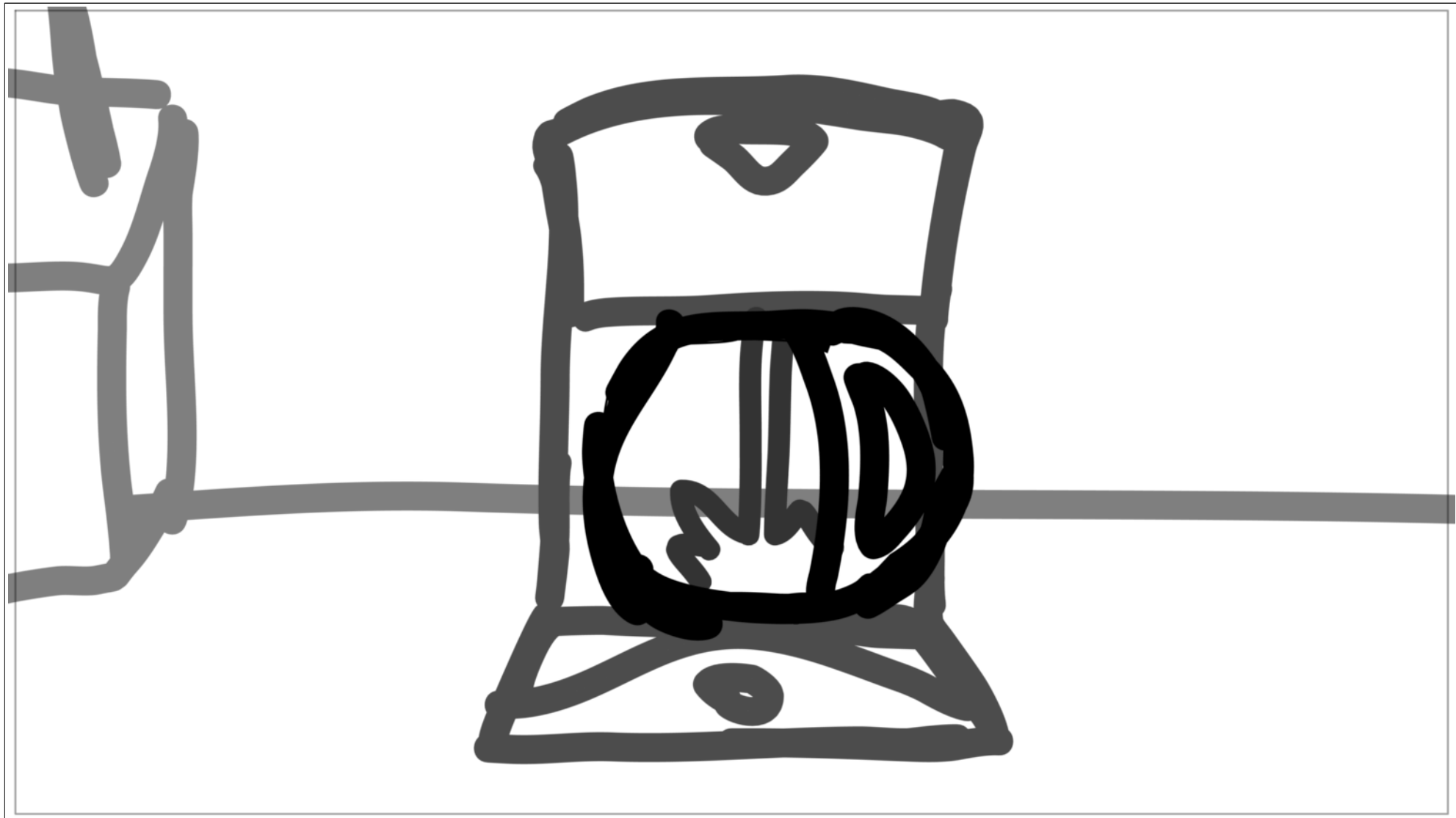

Scene	Duration	Panel	Duration
1	02:19	3	00:17

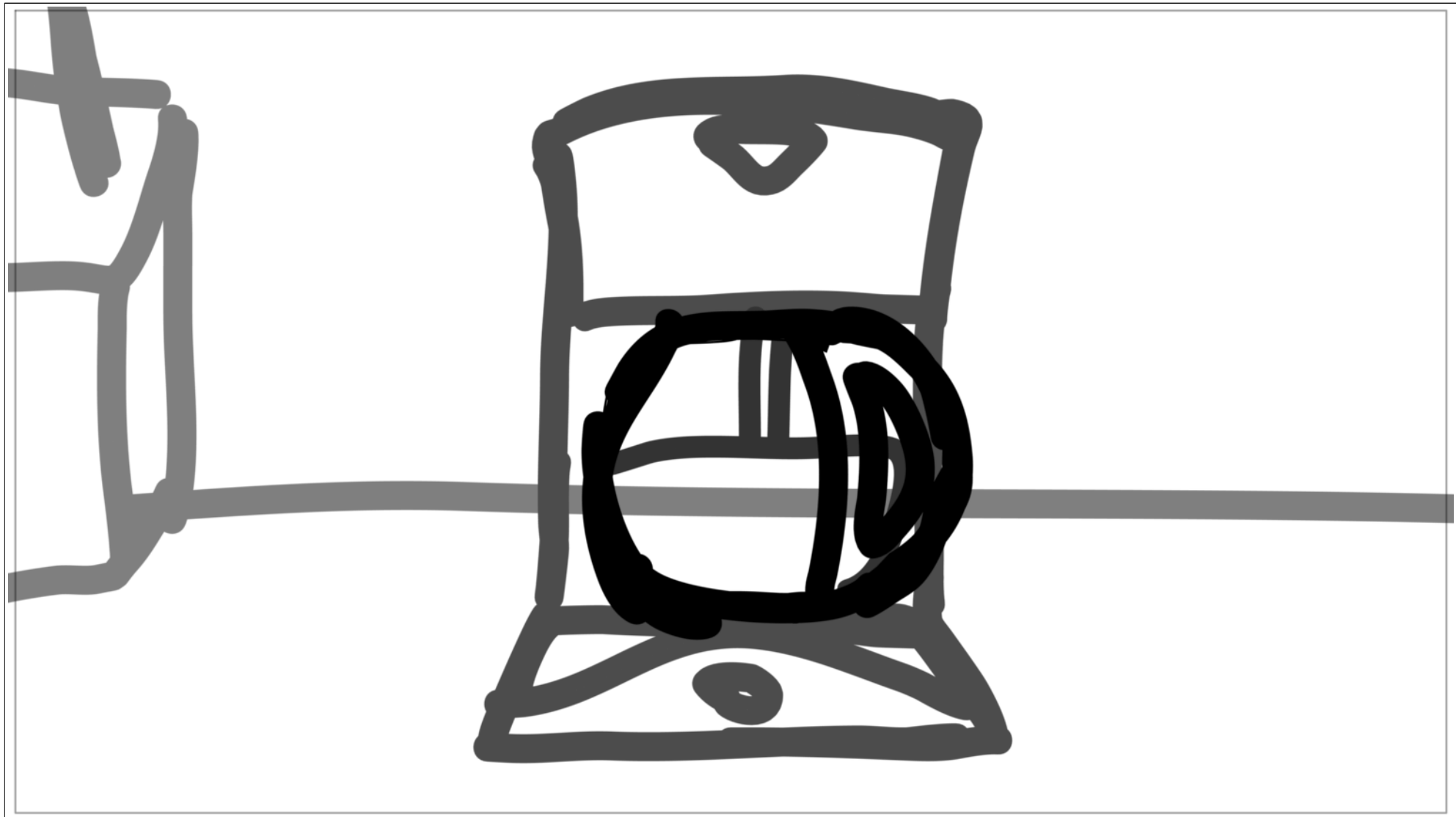

Scene	Duration	Panel	Duration
1	02:19	4	00:23

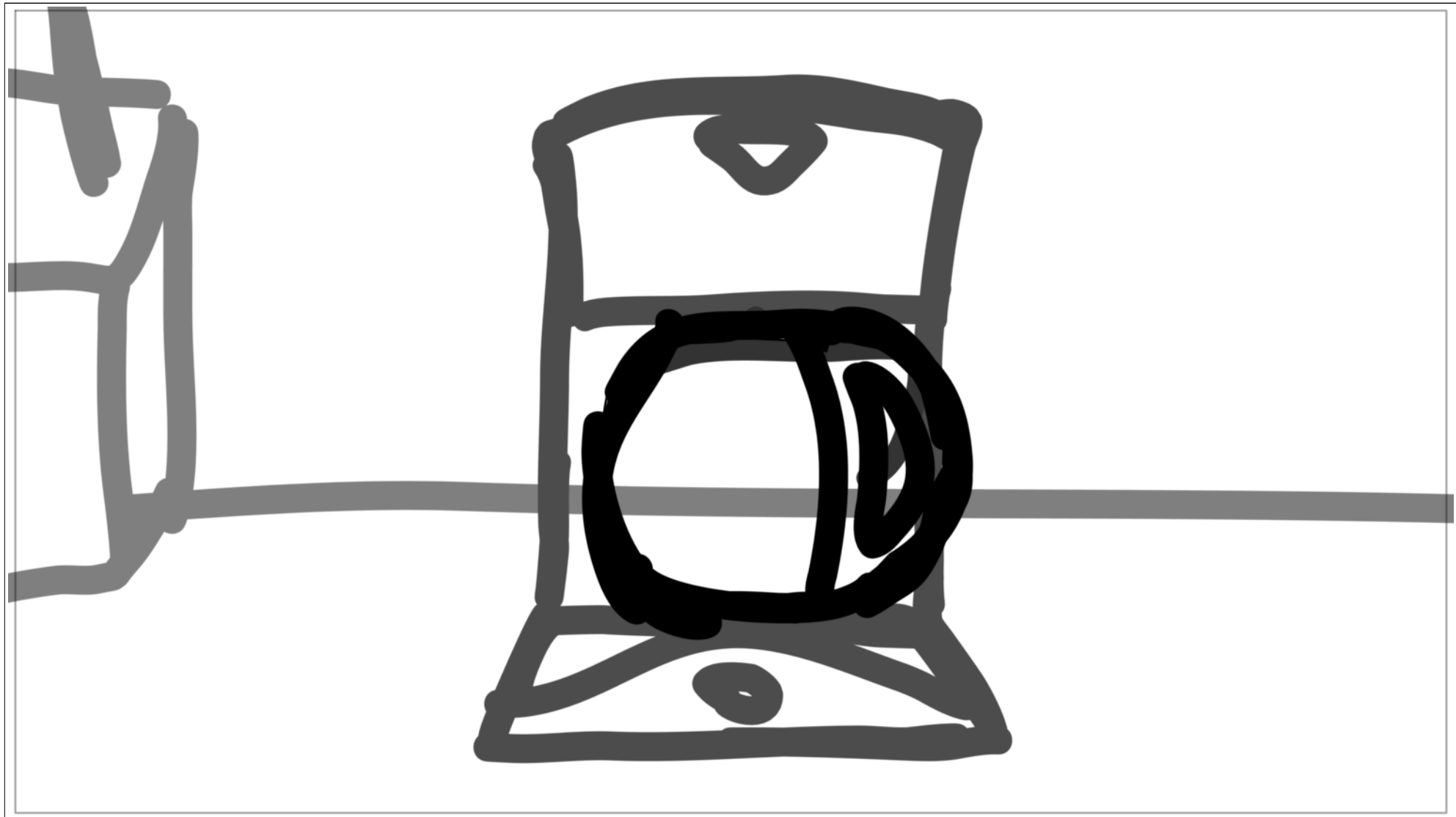

Scene	Duration	Panel	Duration
2	04:19	1	00:23



Scene	Duration	Panel	Duration
2	04:19	2	01:06



Scene	Duration	Panel	Duration
2	04:19	3	01:06



Scene	Duration	Panel	Duration
2	04:19	4	01:08



Scene	Duration	Panel	Duration
3	05:08	1	00:17

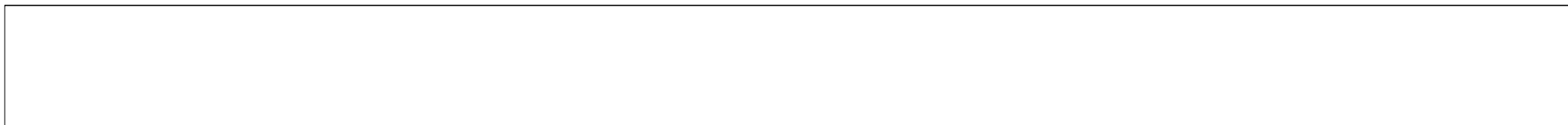
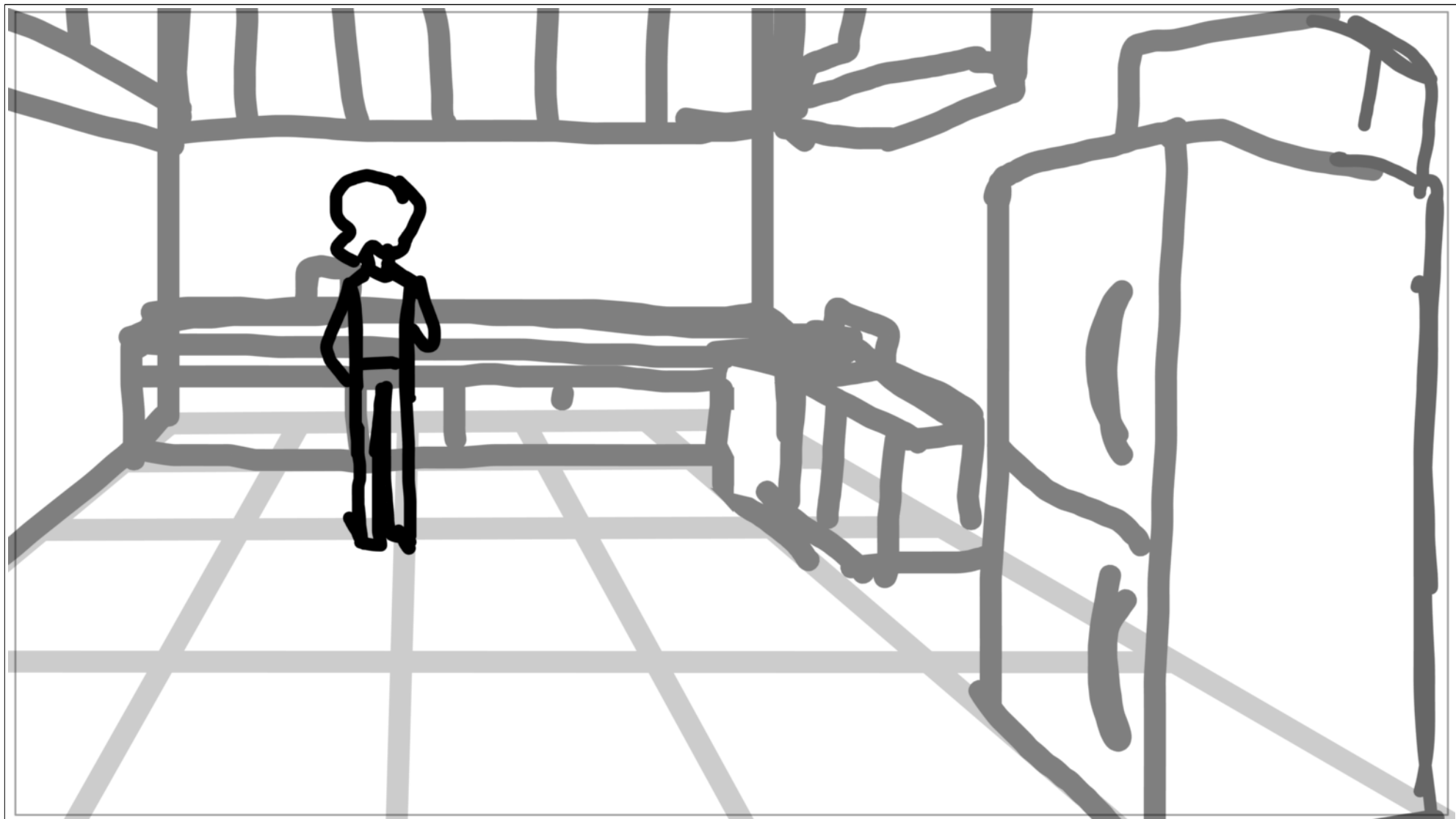

Scene	Duration	Panel	Duration
3	05:08	2	00:21

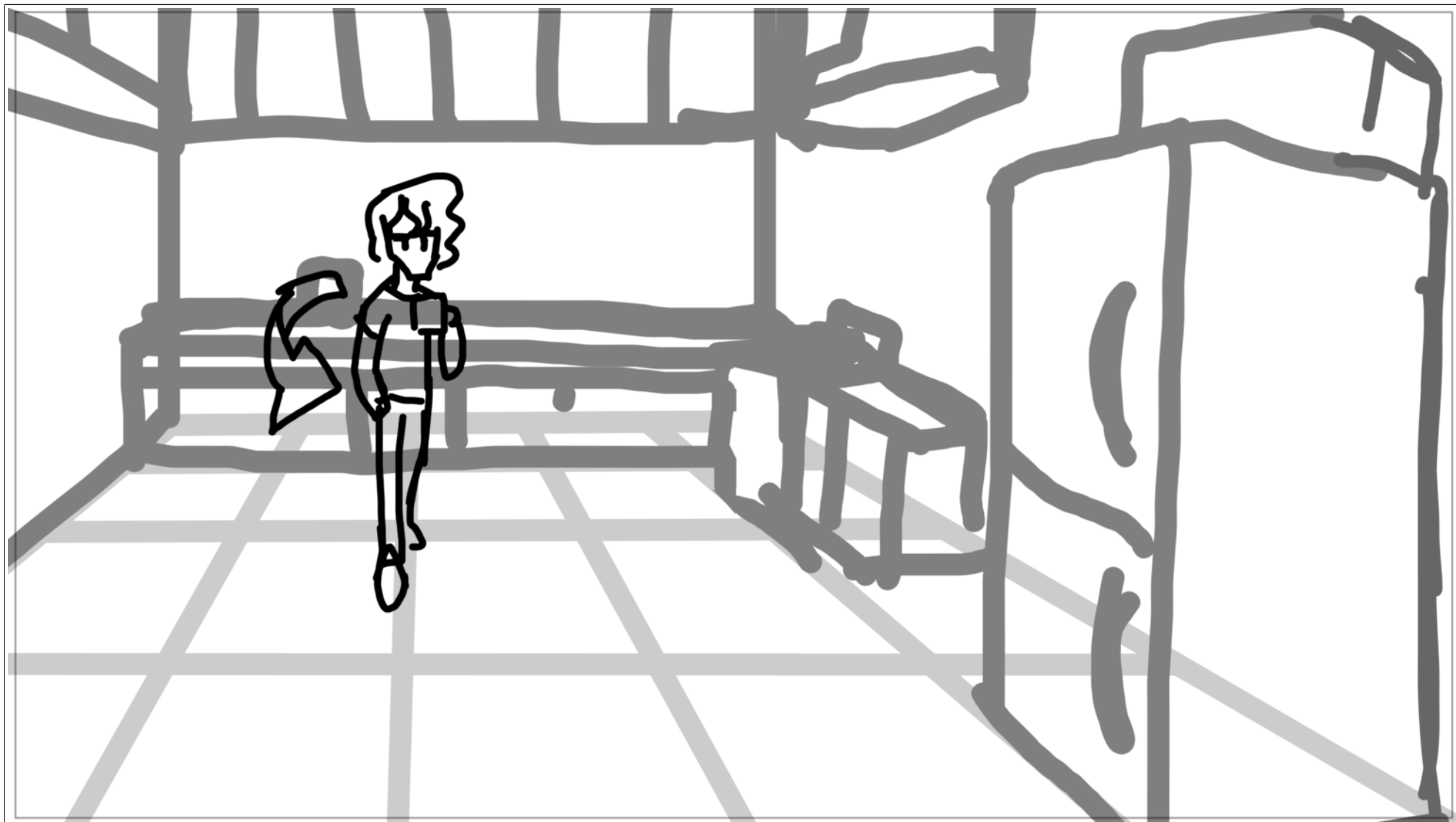

Scene	Duration	Panel	Duration
3	05:08	3	00:22

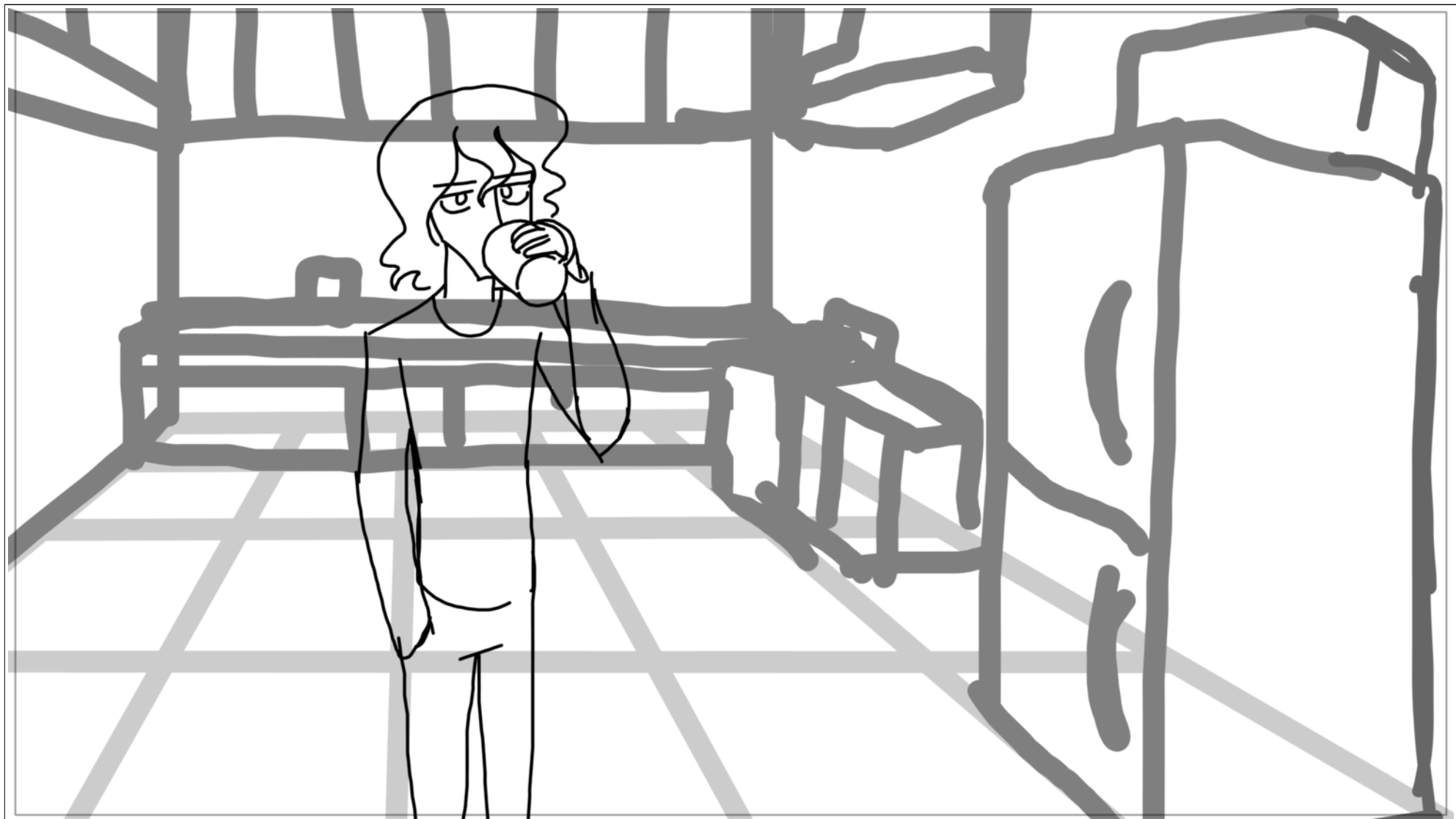

Scene	Duration	Panel	Duration
3	05:08	4	00:19



Scene	Duration	Panel	Duration
3	05:08	5	00:21

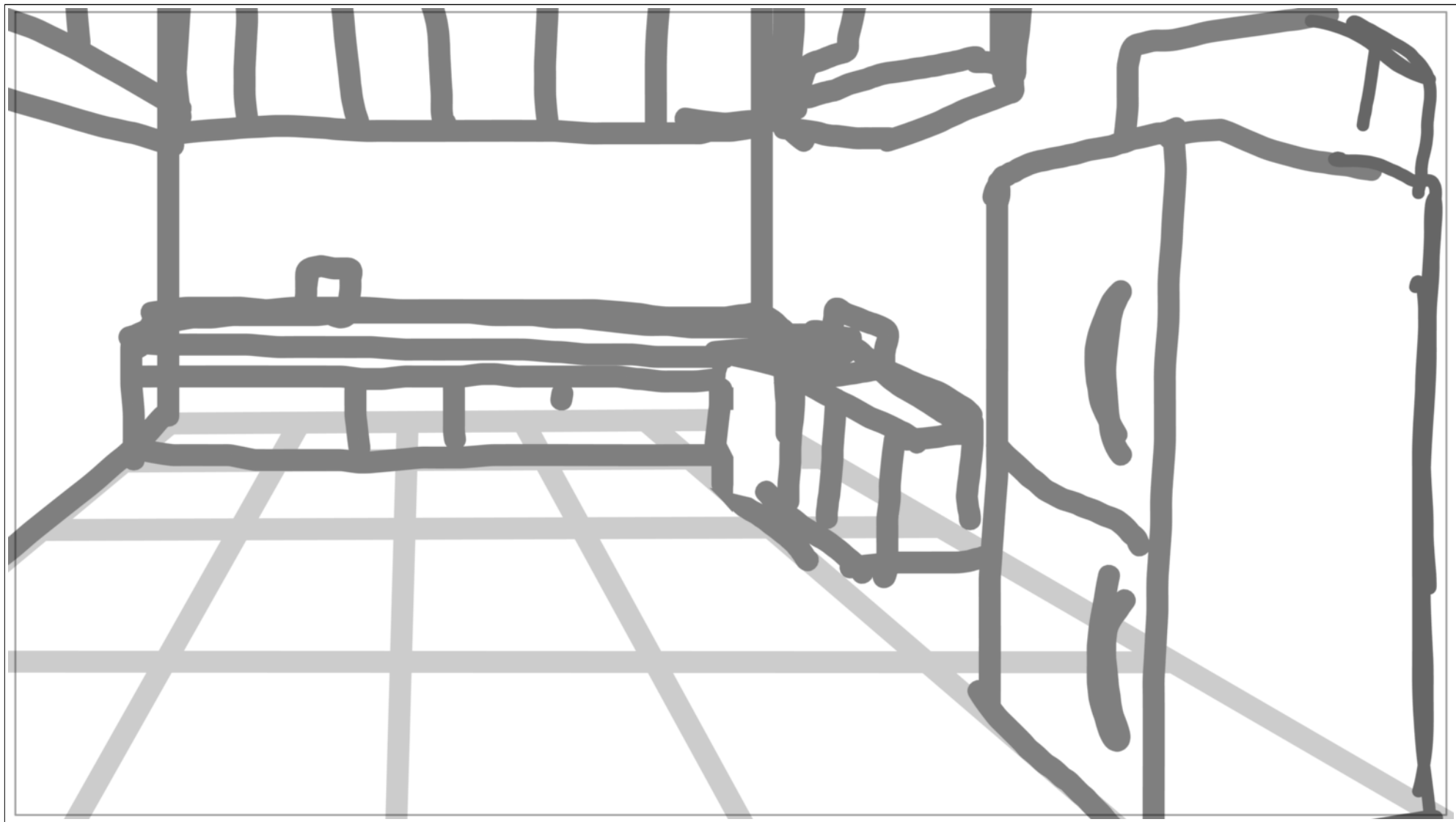

Scene	Duration	Panel	Duration
3	05:08	6	00:10

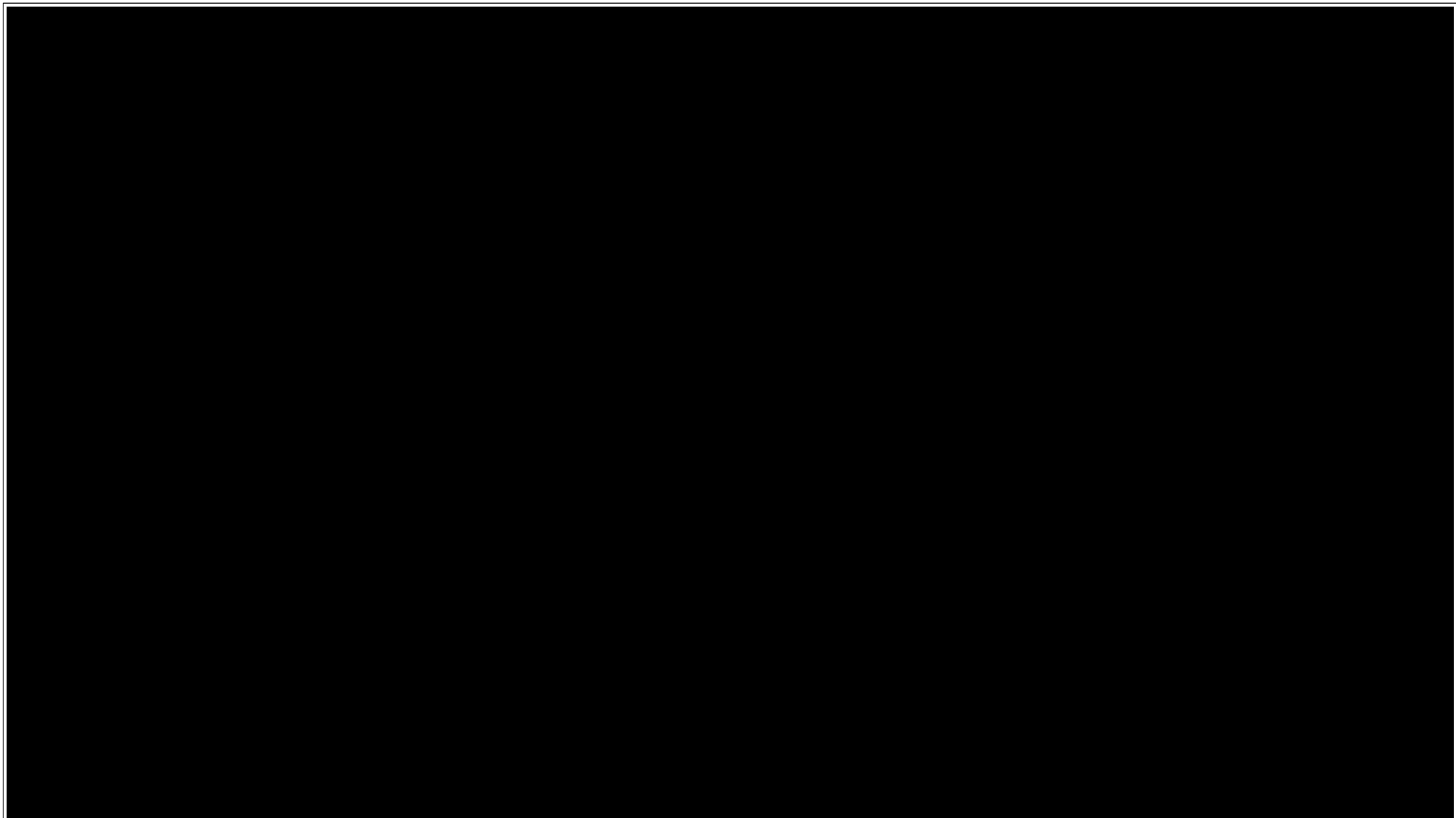

Scene	Duration	Panel	Duration
3	05:08	7	00:18



Scene	Duration	Panel	Duration
4	07:10	1	01:00



Scene	Duration	Panel	Duration
4	07:10	2	00:17



Scene	Duration	Panel	Duration
4	07:10	3	00:17



Scene	Duration	Panel	Duration
4	07:10	4	00:12



Scene	Duration	Panel	Duration
4	07:10	5	00:23



Scene	Duration	Panel	Duration
4	07:10	6	00:20



Scene	Duration	Panel	Duration
4	07:10	7	00:23



Scene	Duration	Panel	Duration
4	07:10	8	00:18



Scene	Duration	Panel	Duration
4	07:10	9	01:00



Scene	Duration	Panel	Duration
5	01:07	1	01:07

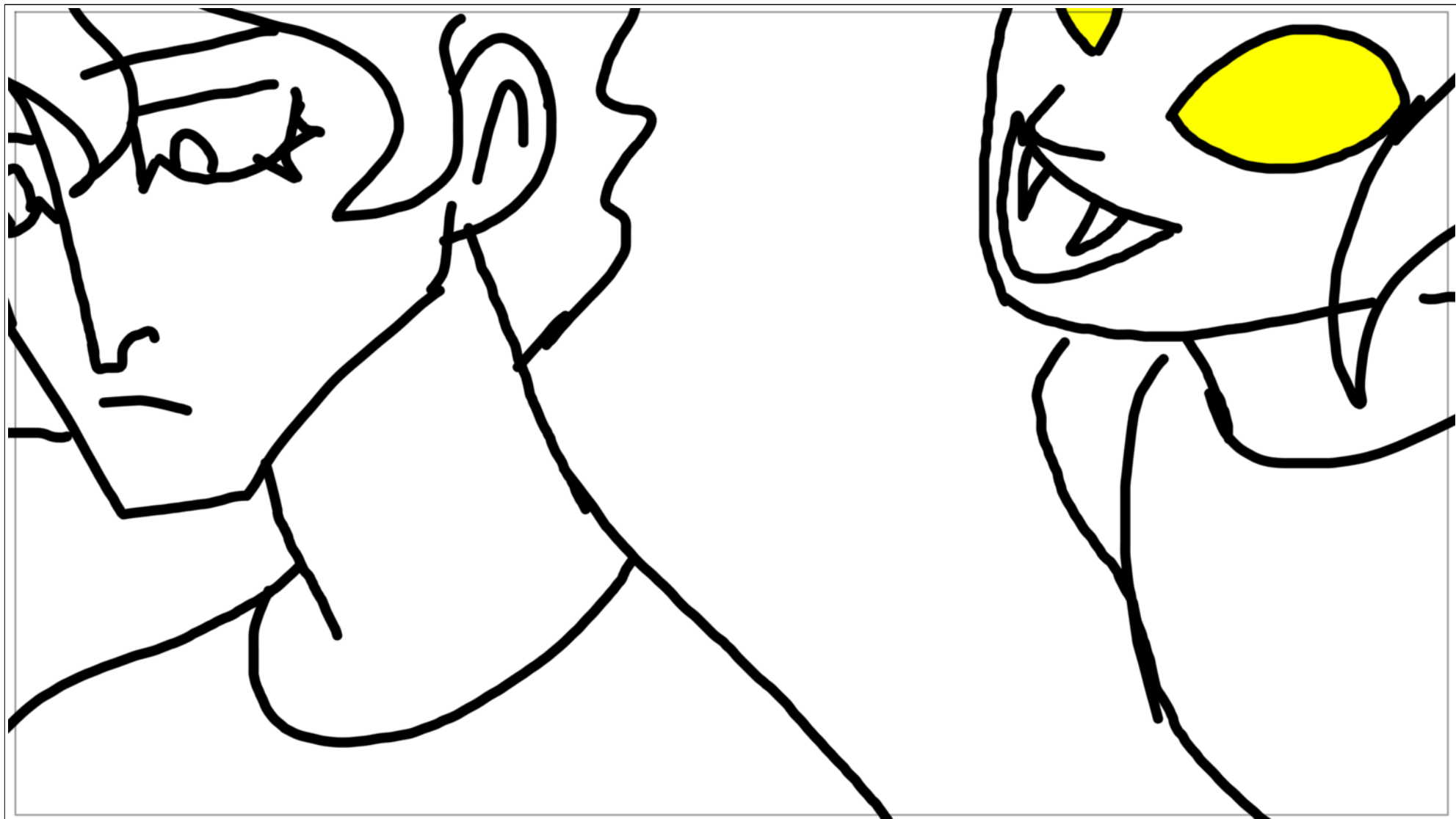

Scene	Duration	Panel	Duration
6	01:08	1	00:15

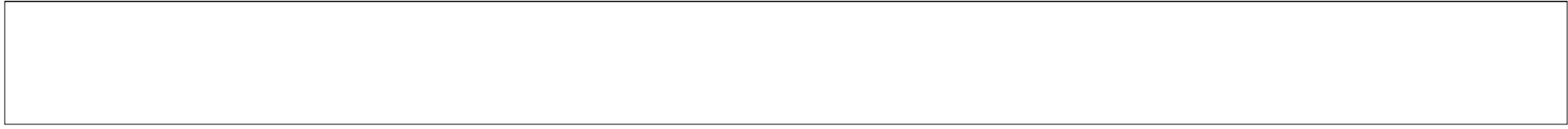
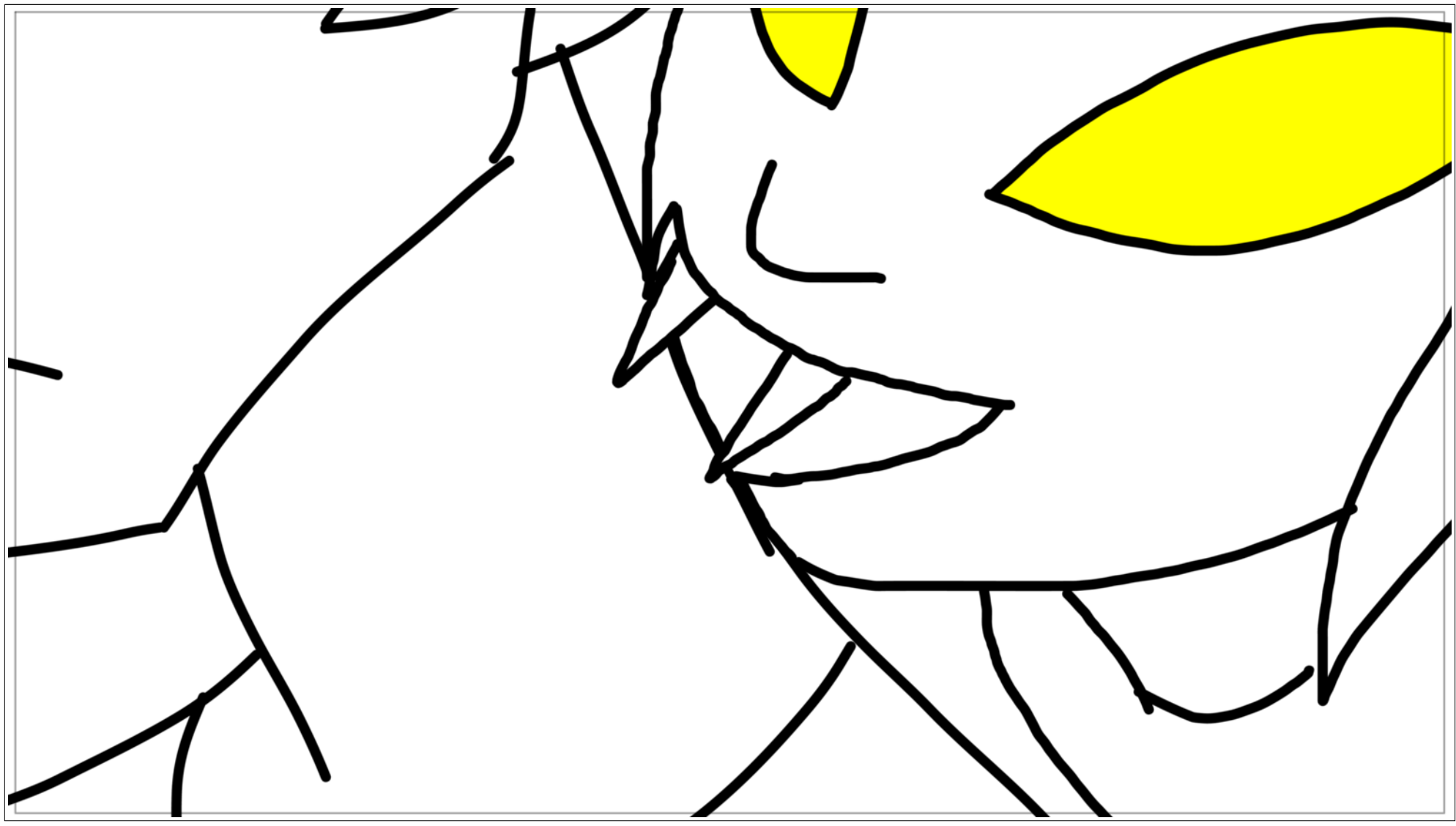

Scene	Duration	Panel	Duration
6	01:08	2	00:17



Scene	Duration	Panel	Duration
7	00:17	1	00:17



Scene	Duration	Panel	Duration
8	00:15	1	00:06

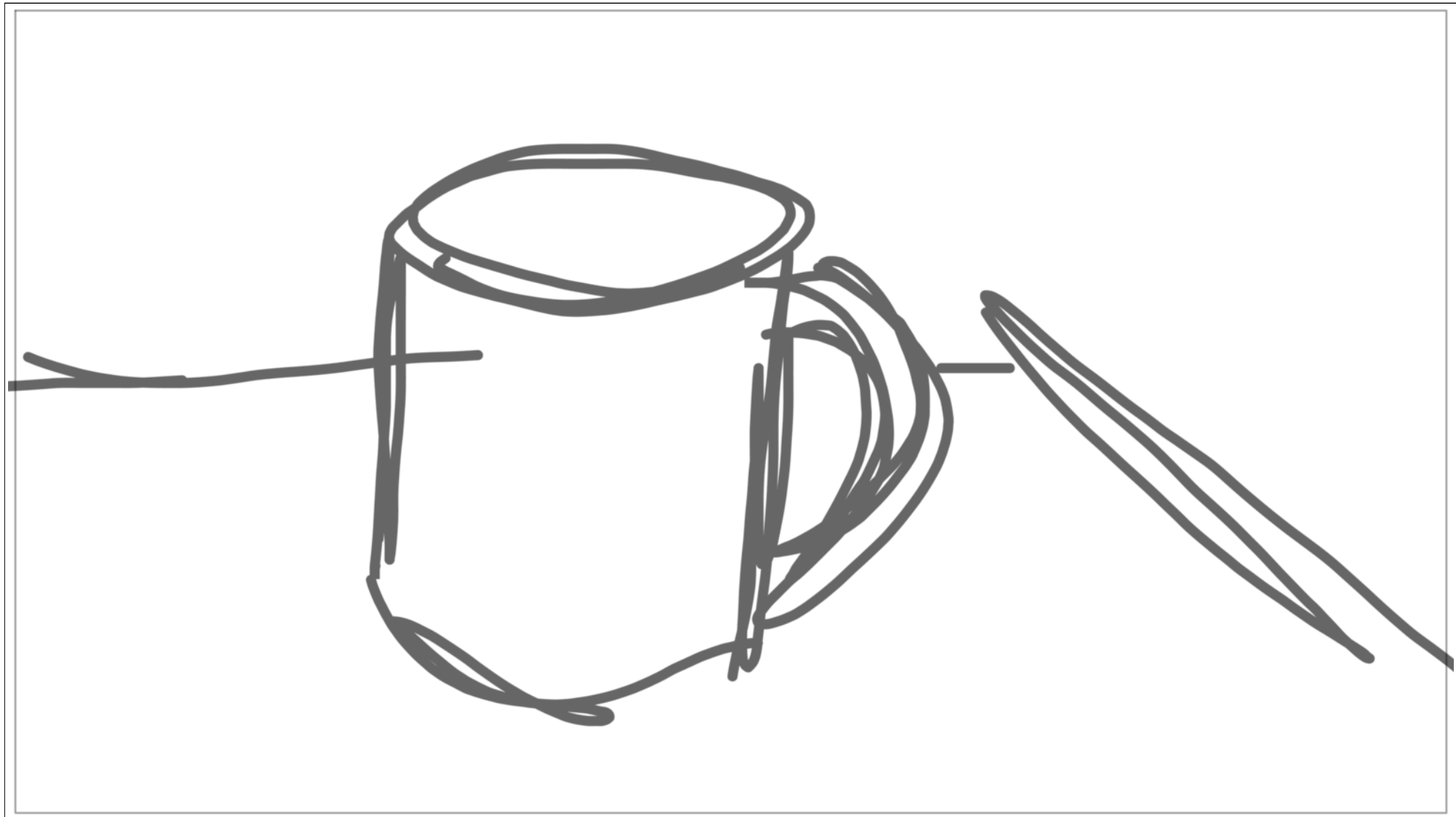

Scene	Duration	Panel	Duration
8	00:15	2	00:09

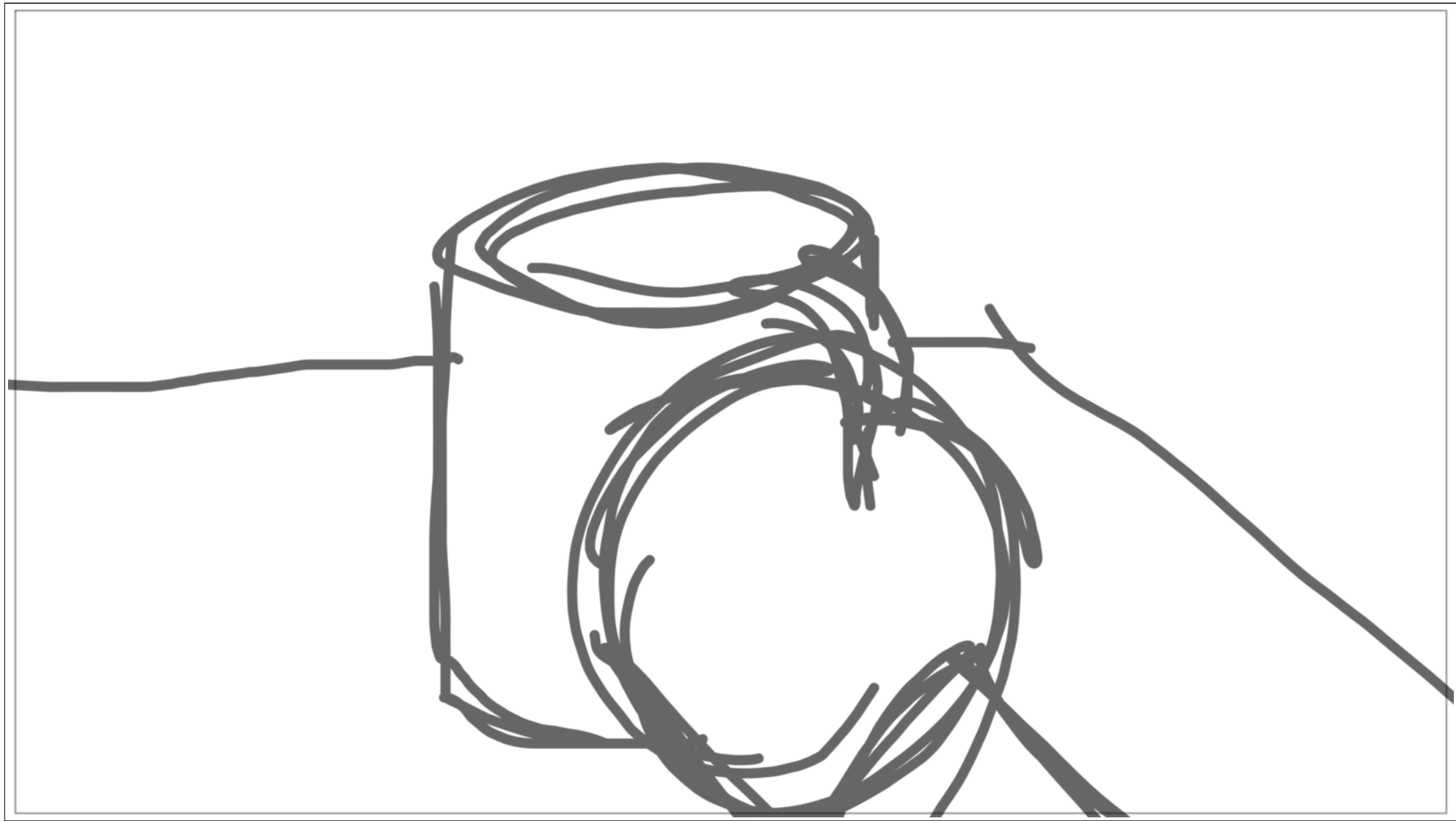

Scene	Duration	Panel	Duration
9	00:22	1	00:09

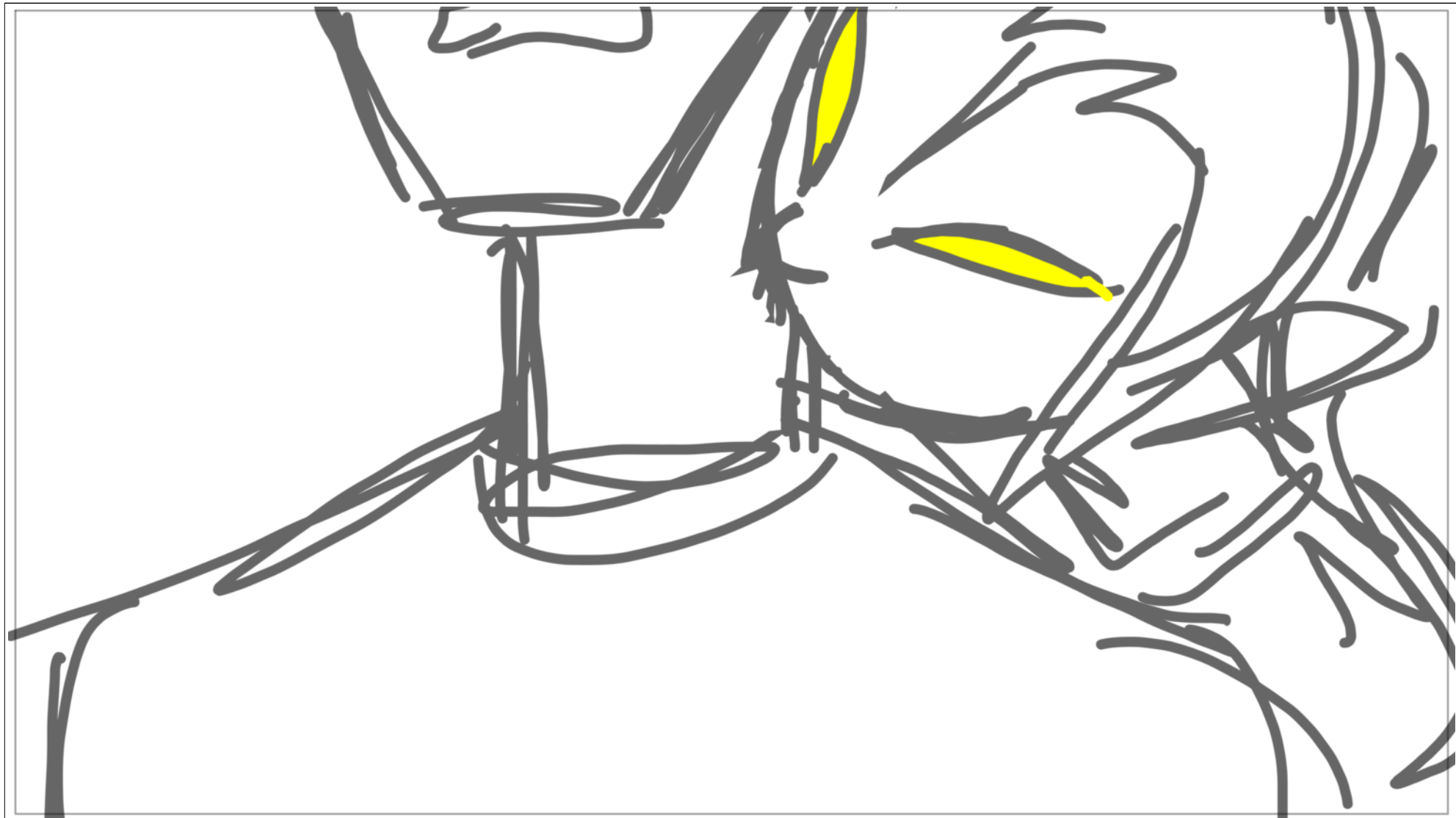

Scene	Duration	Panel	Duration
9	00:22	2	00:05



Scene	Duration	Panel	Duration
9	00:22	3	00:08

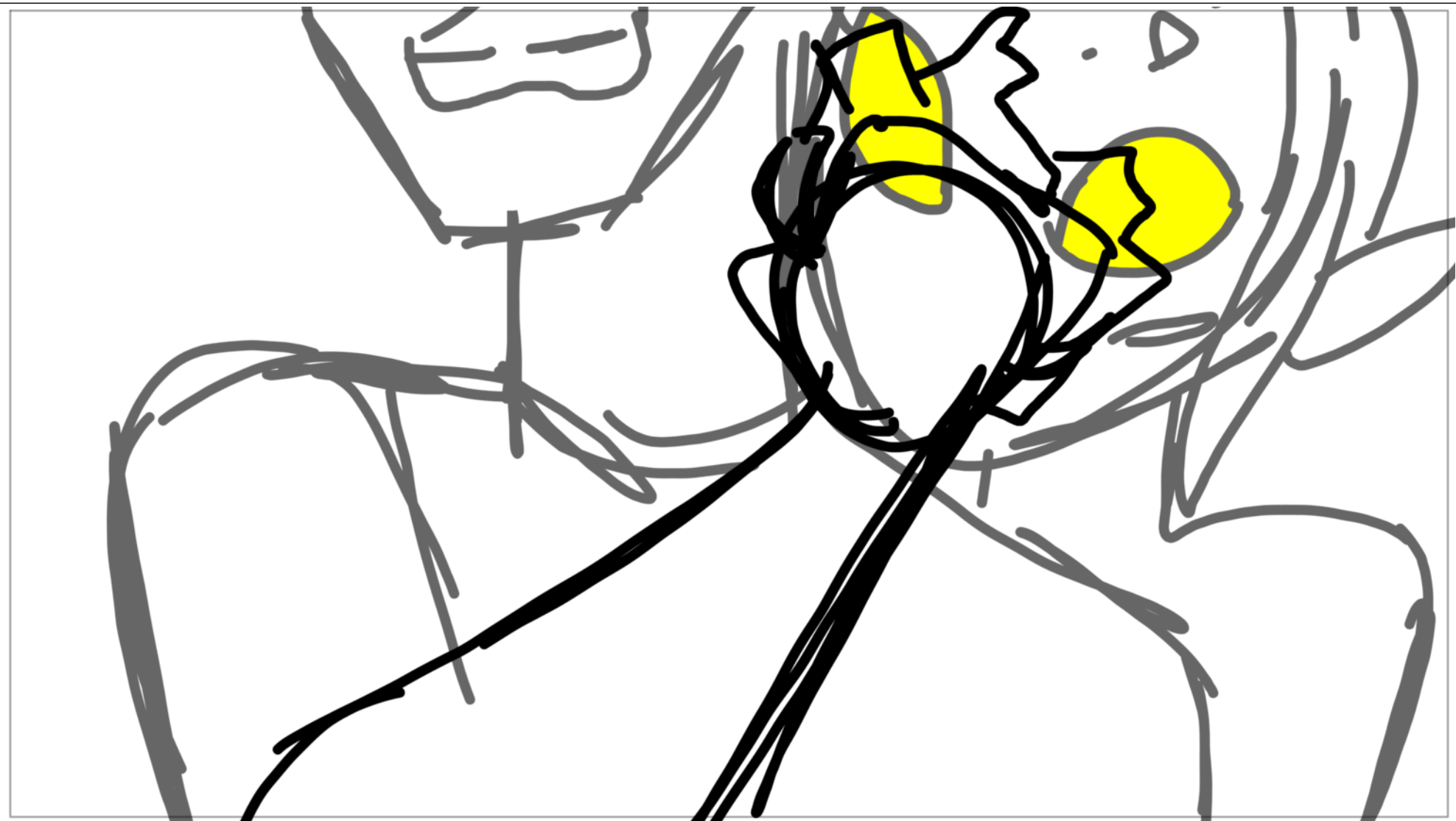

Scene	Duration	Panel	Duration
10	01:11	1	00:12

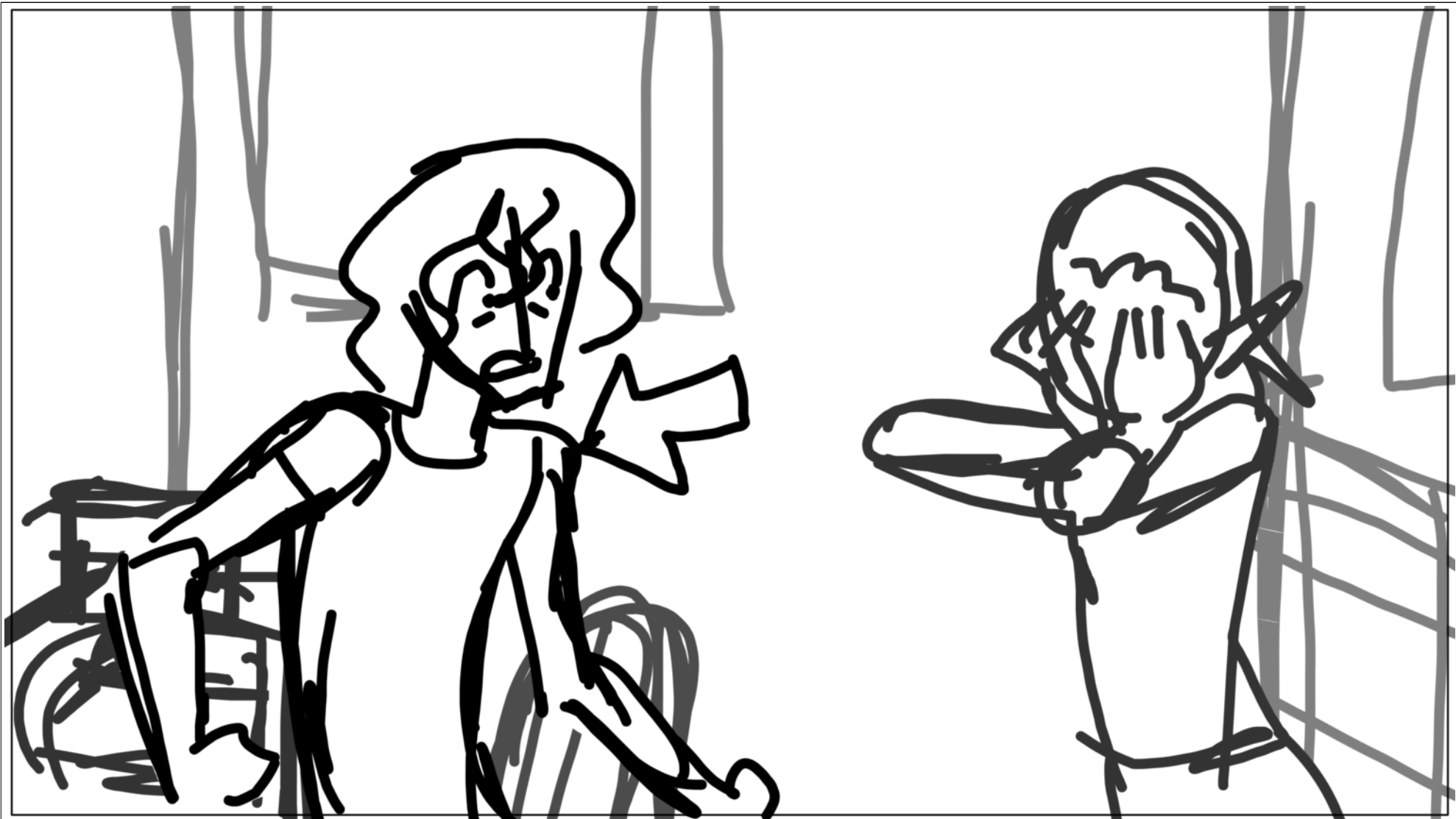

Scene	Duration	Panel	Duration
10	01:11	2	00:23

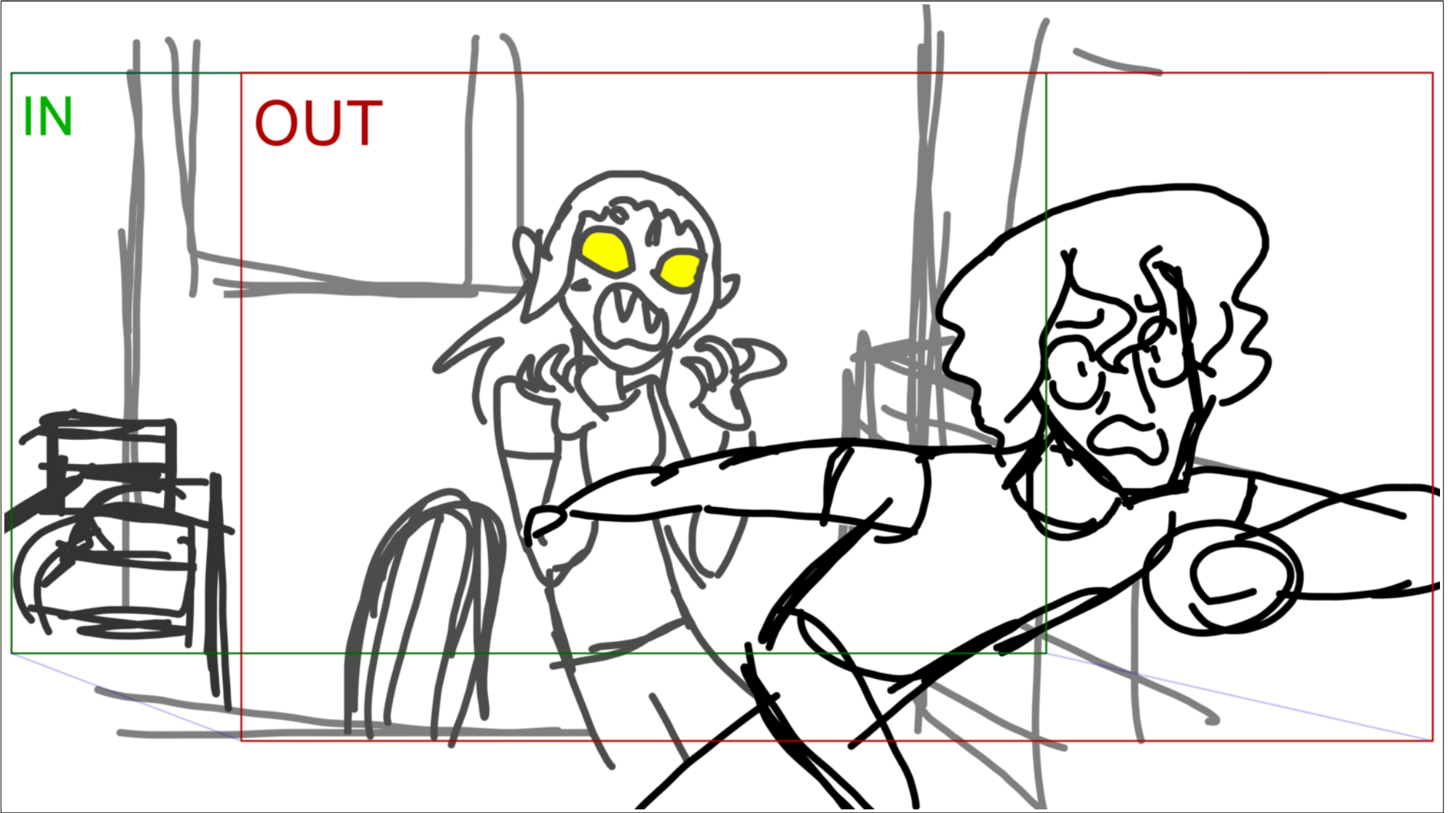

Scene	Duration	Panel	Duration
11	01:10	1	01:03

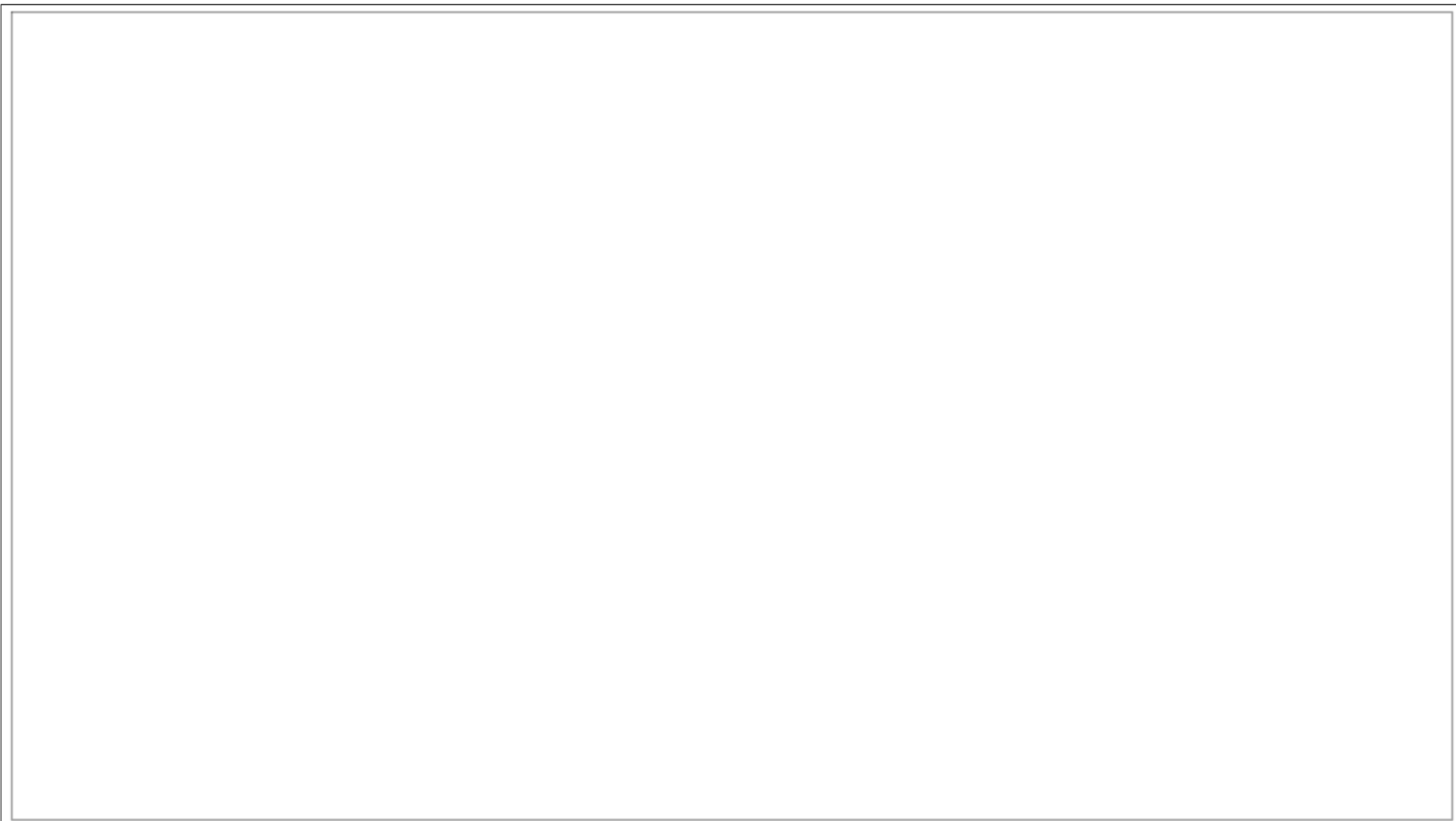

Scene	Duration	Panel	Duration
11	01:10	2	00:07

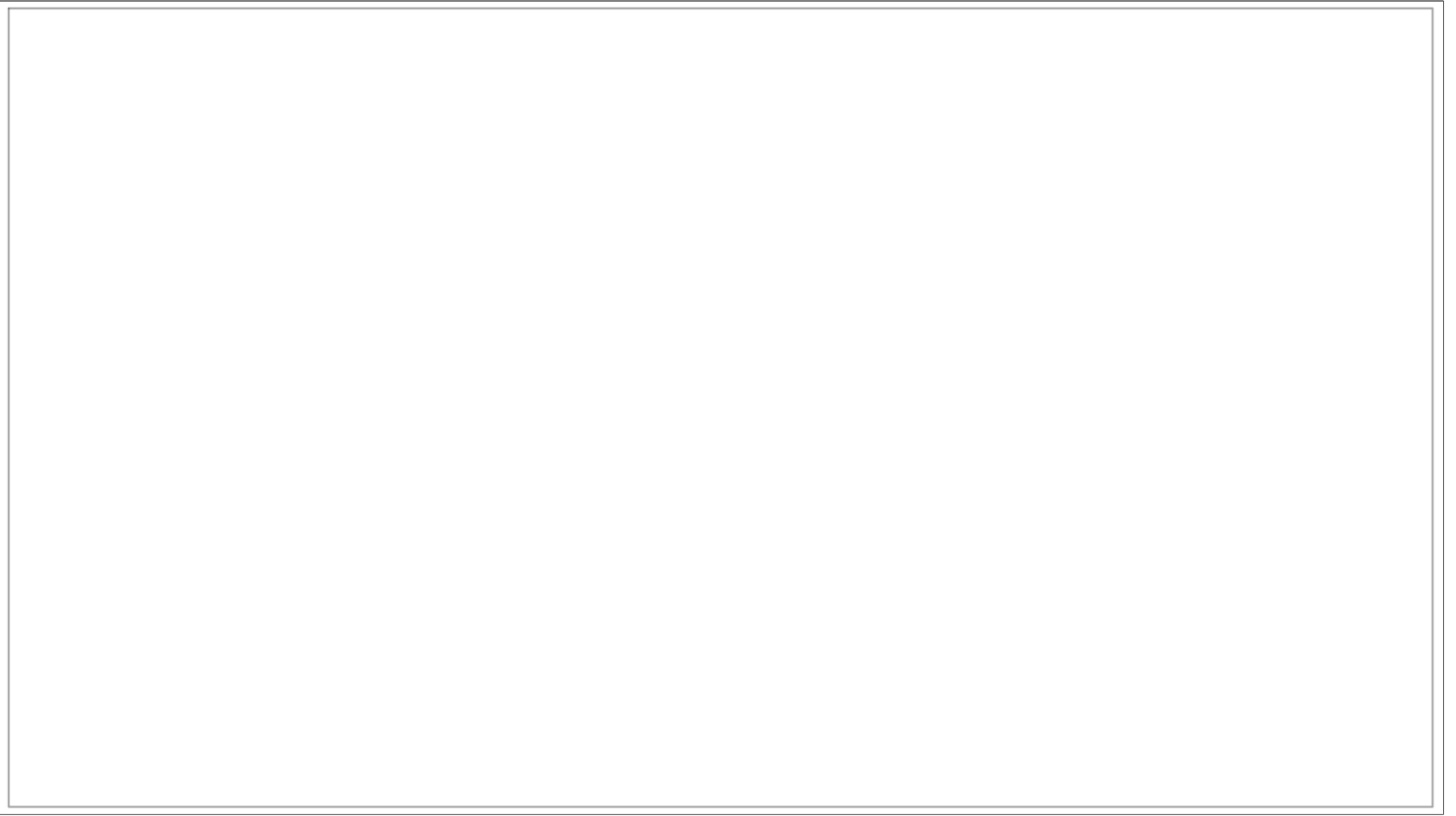

Scene	Duration	Panel	Duration
12	03:13	1	00:12

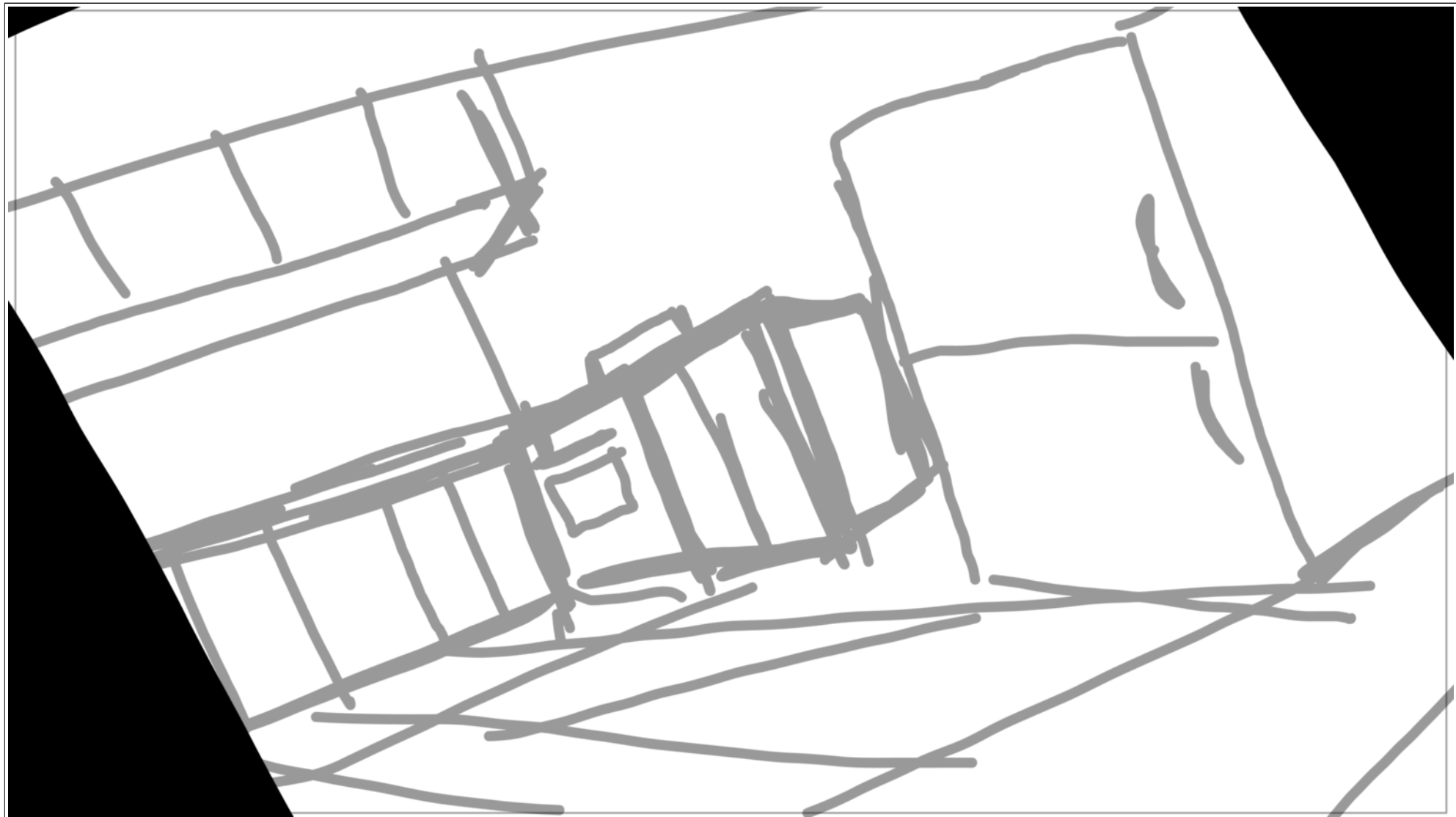

Scene	Duration	Panel	Duration
12	03:13	2	00:18



Scene	Duration	Panel	Duration
12	03:13	3	00:12



Scene	Duration	Panel	Duration
12	03:13	4	00:19

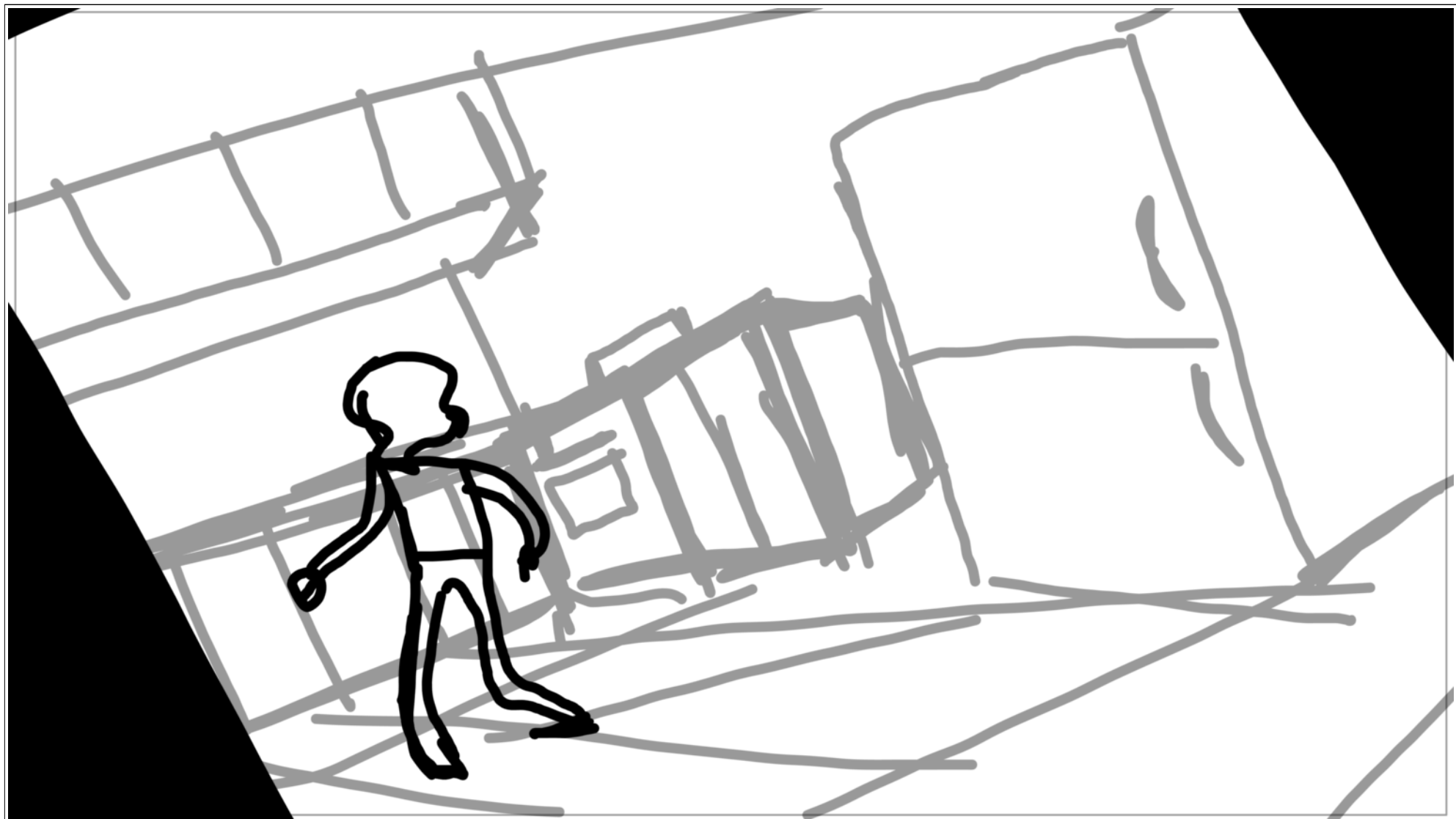

Scene	Duration	Panel	Duration
12	03:13	5	01:00



Scene	Duration	Panel	Duration
13	01:17	1	00:12

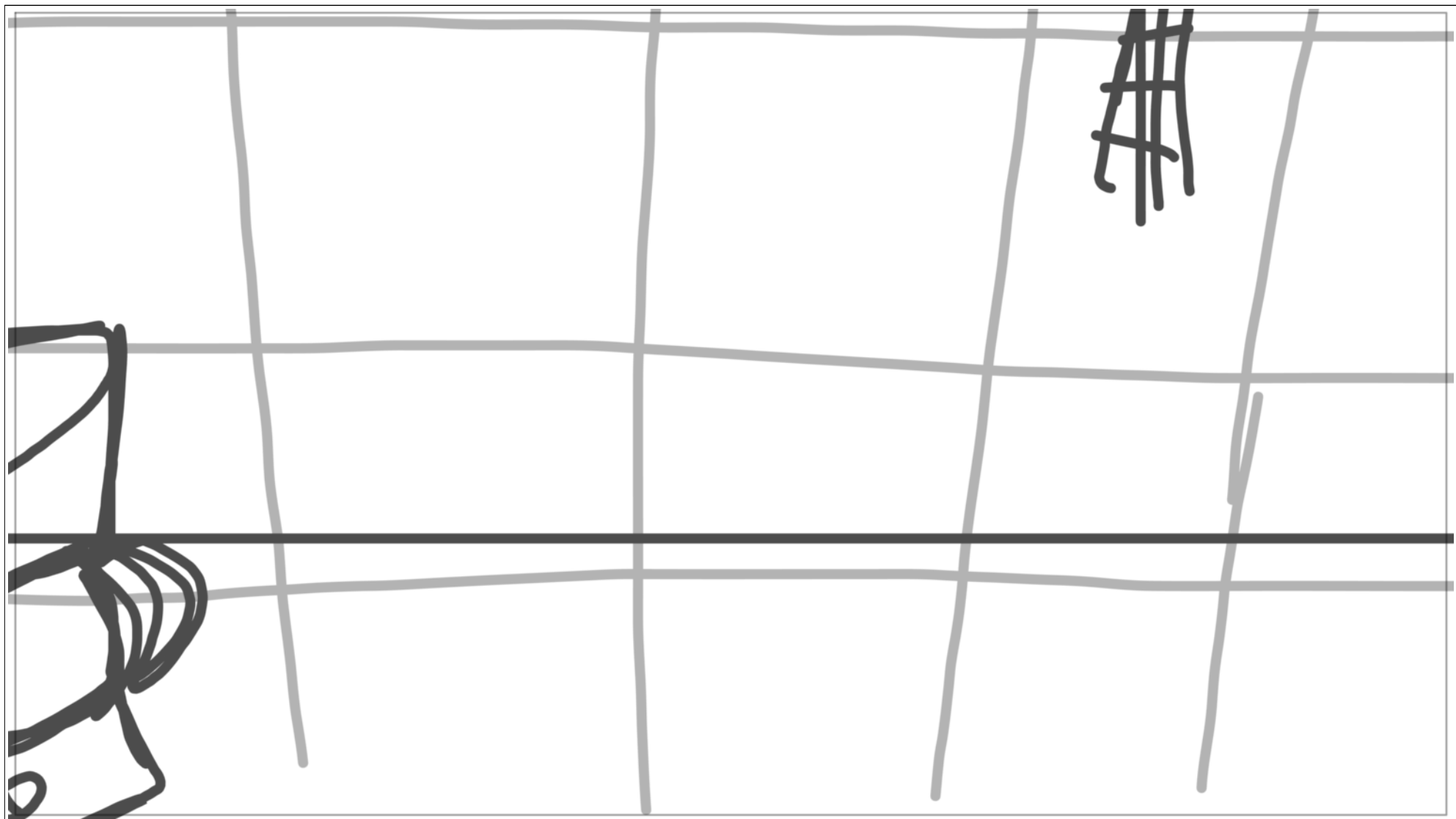

Scene	Duration	Panel	Duration
13	01:17	2	00:12



Scene	Duration	Panel	Duration
13	01:17	3	00:17



Scene	Duration	Panel	Duration
14	00:20	1	00:20



Scene	14_A	Duration	01:08	Panel	1	Duration	00:11
-------	------	----------	-------	-------	---	----------	-------



Scene	14_A	Duration	01:08	Panel	2	Duration	00:21
-------	------	----------	-------	-------	---	----------	-------

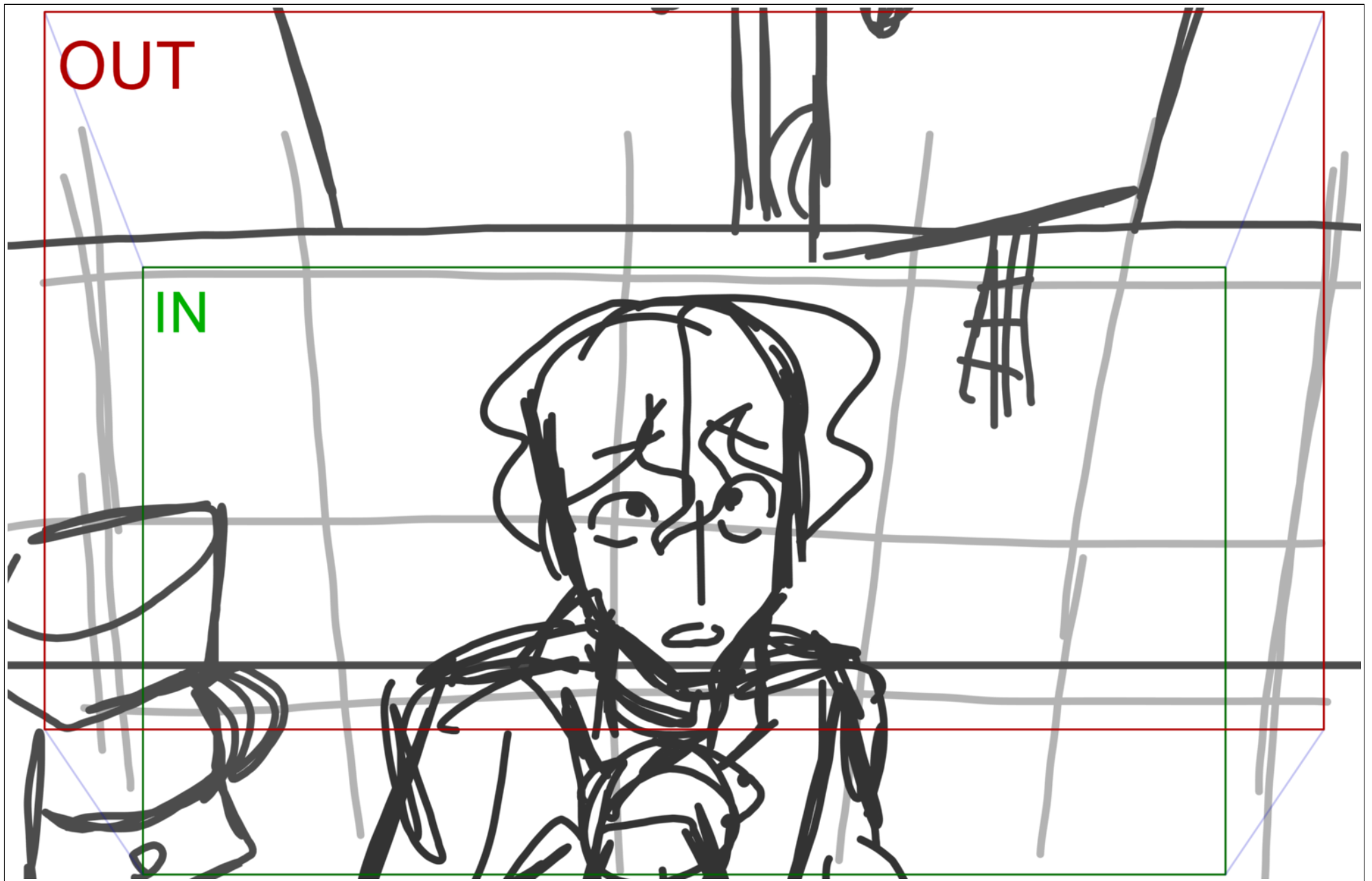

Scene	Duration	Panel	Duration
14_B	01:02	1	00:14

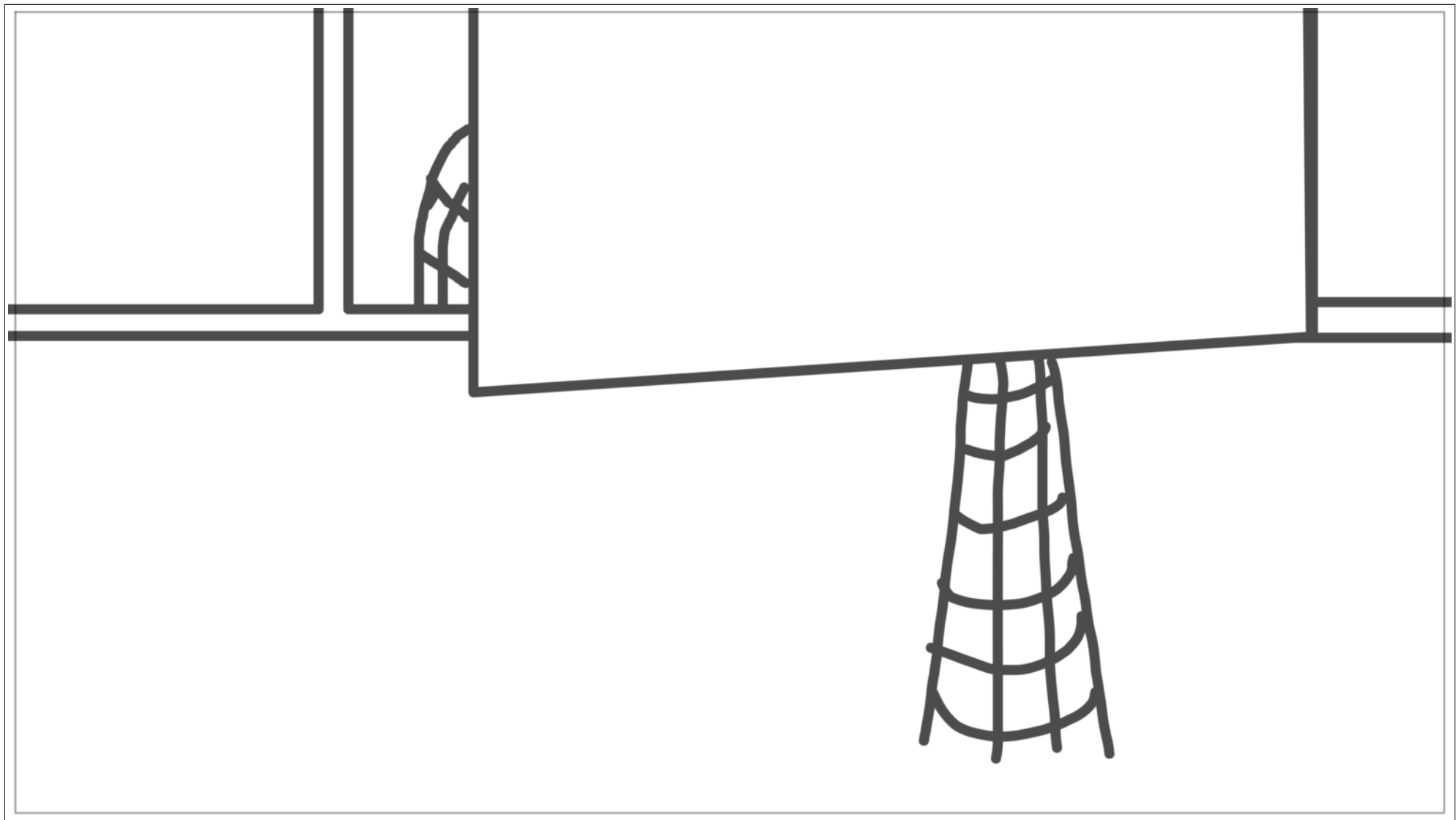

Scene	Duration	Panel	Duration
14_B	01:02	2	00:12

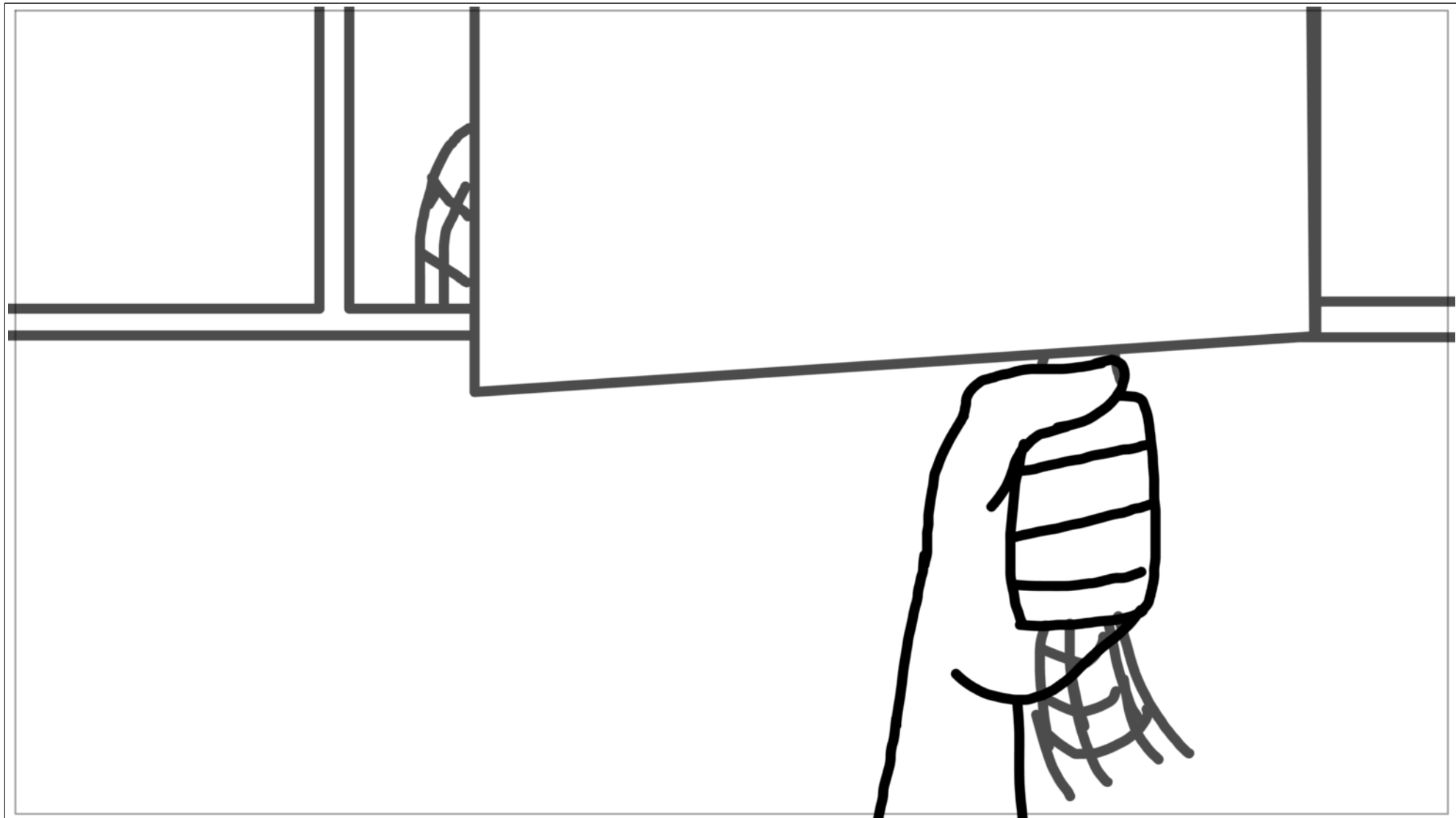

Scene	Duration	Panel	Duration
14_C	00:13	1	00:13



Scene	14_D	Duration	00:20	Panel	1	Duration	00:10
-------	------	----------	-------	-------	---	----------	-------



Scene	14_D	Duration	00:20	Panel	2	Duration	00:10
-------	------	----------	-------	-------	---	----------	-------

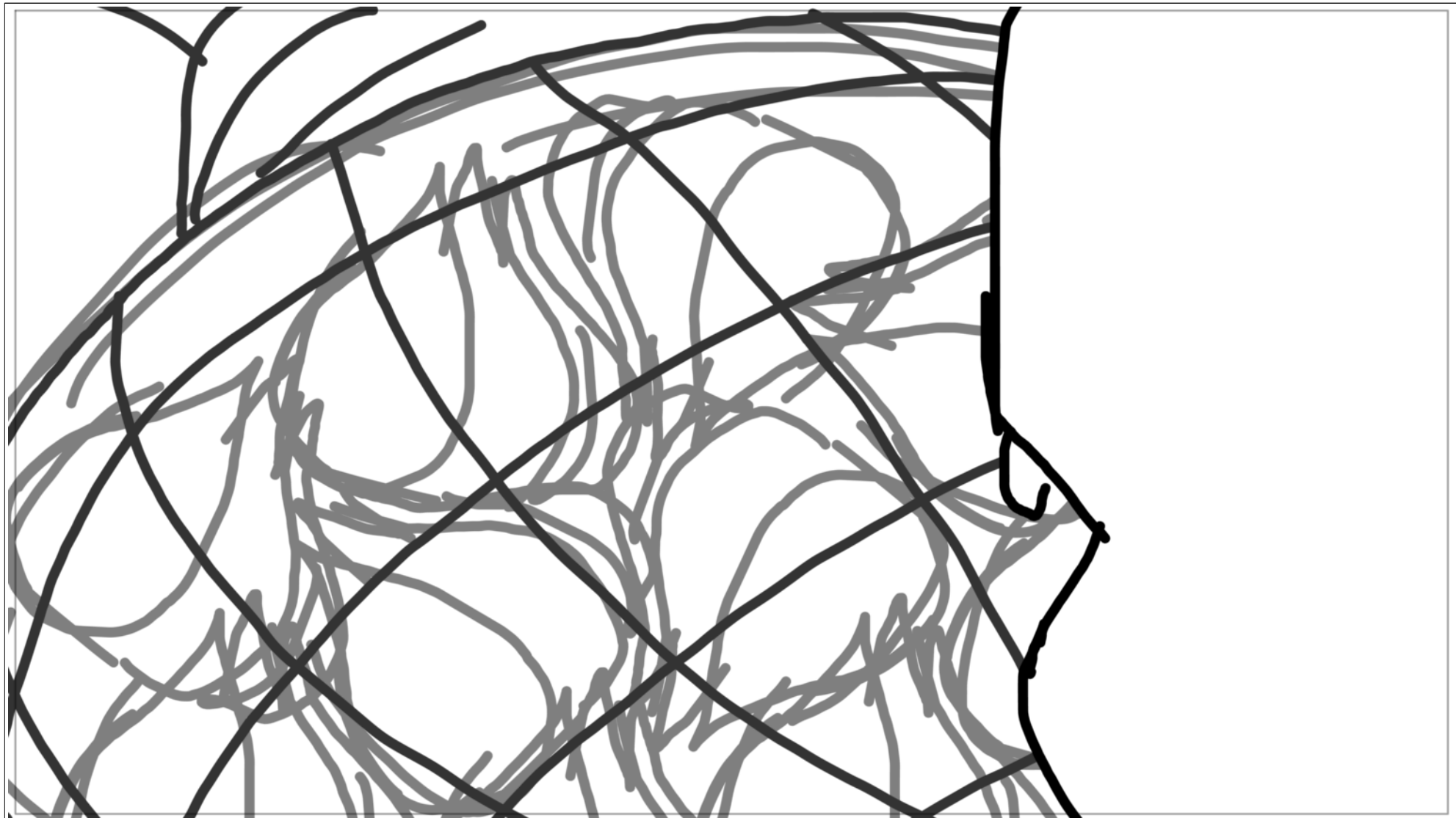

Scene	Duration	Panel	Duration
14_E	02:00	1	00:17



Scene	14_E	Duration	02:00	Panel	2	Duration	00:17
-------	------	----------	-------	-------	---	----------	-------



Scene	14_E	Duration	02:00	Panel	3	Duration	00:14
-------	------	----------	-------	-------	---	----------	-------

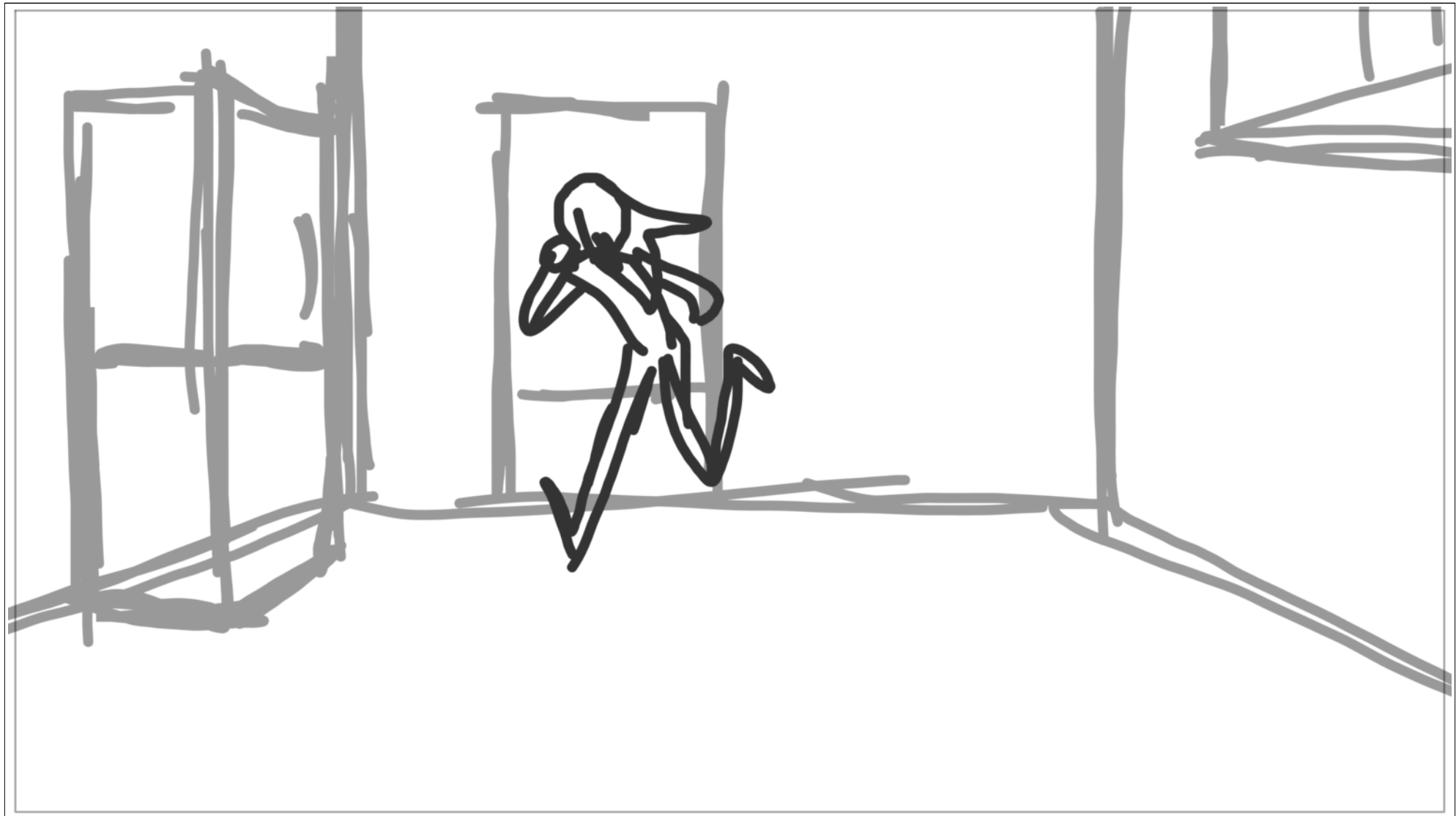

Scene	Duration	Panel	Duration
14_F	05:18	1	01:00

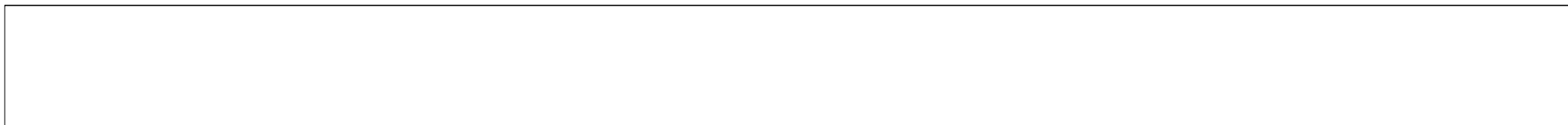

Scene	Duration	Panel	Duration
14_F	05:18	2	02:08

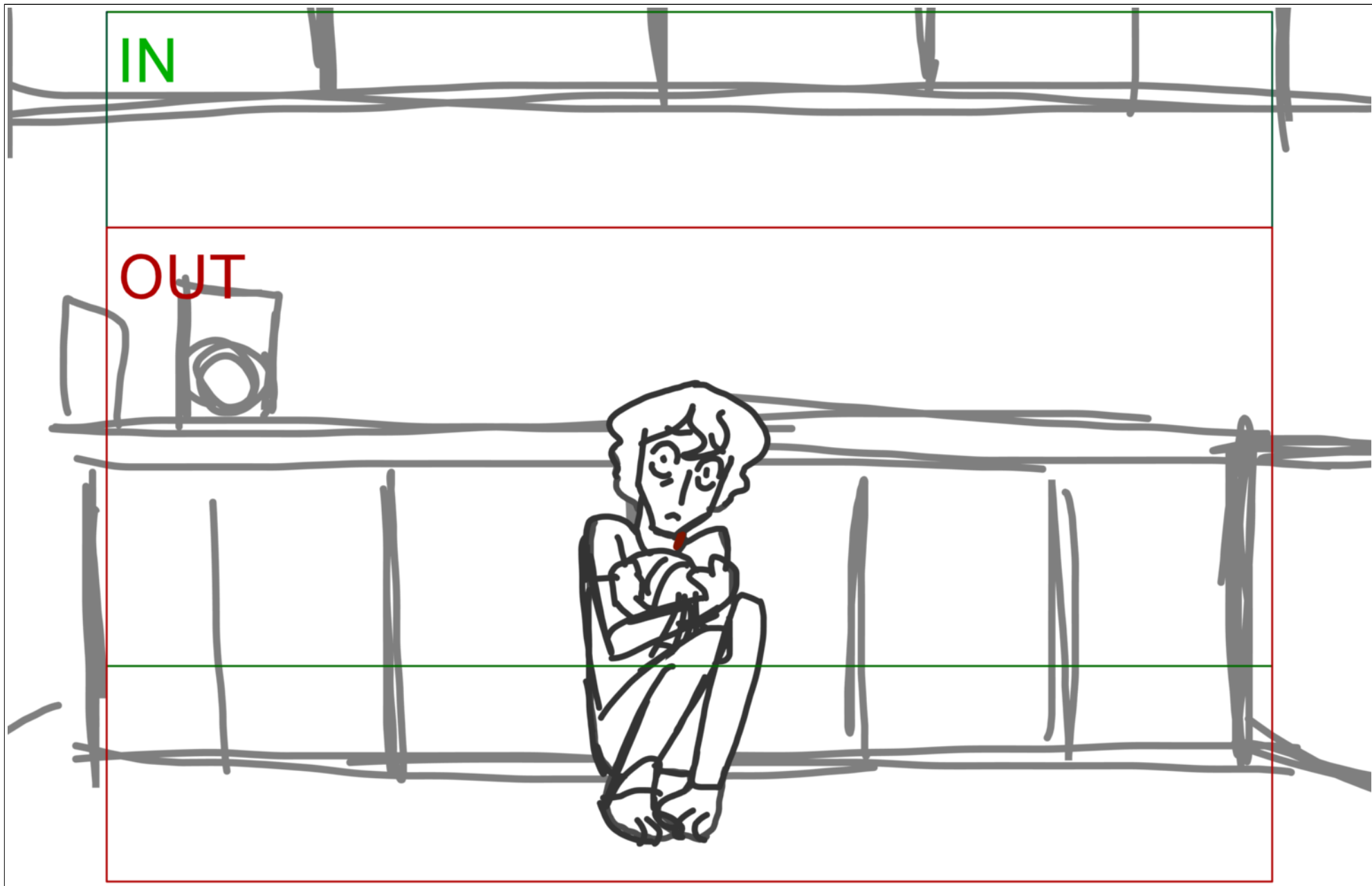

Scene	Duration	Panel	Duration
14_F	05:18	3	01:04



Scene	14_F	Duration	05:18	Panel	4	Duration	01:06
-------	------	----------	-------	-------	---	----------	-------



Scene	14_G	Duration	01:07	Panel	1	Duration	01:07
-------	------	----------	-------	-------	---	----------	-------

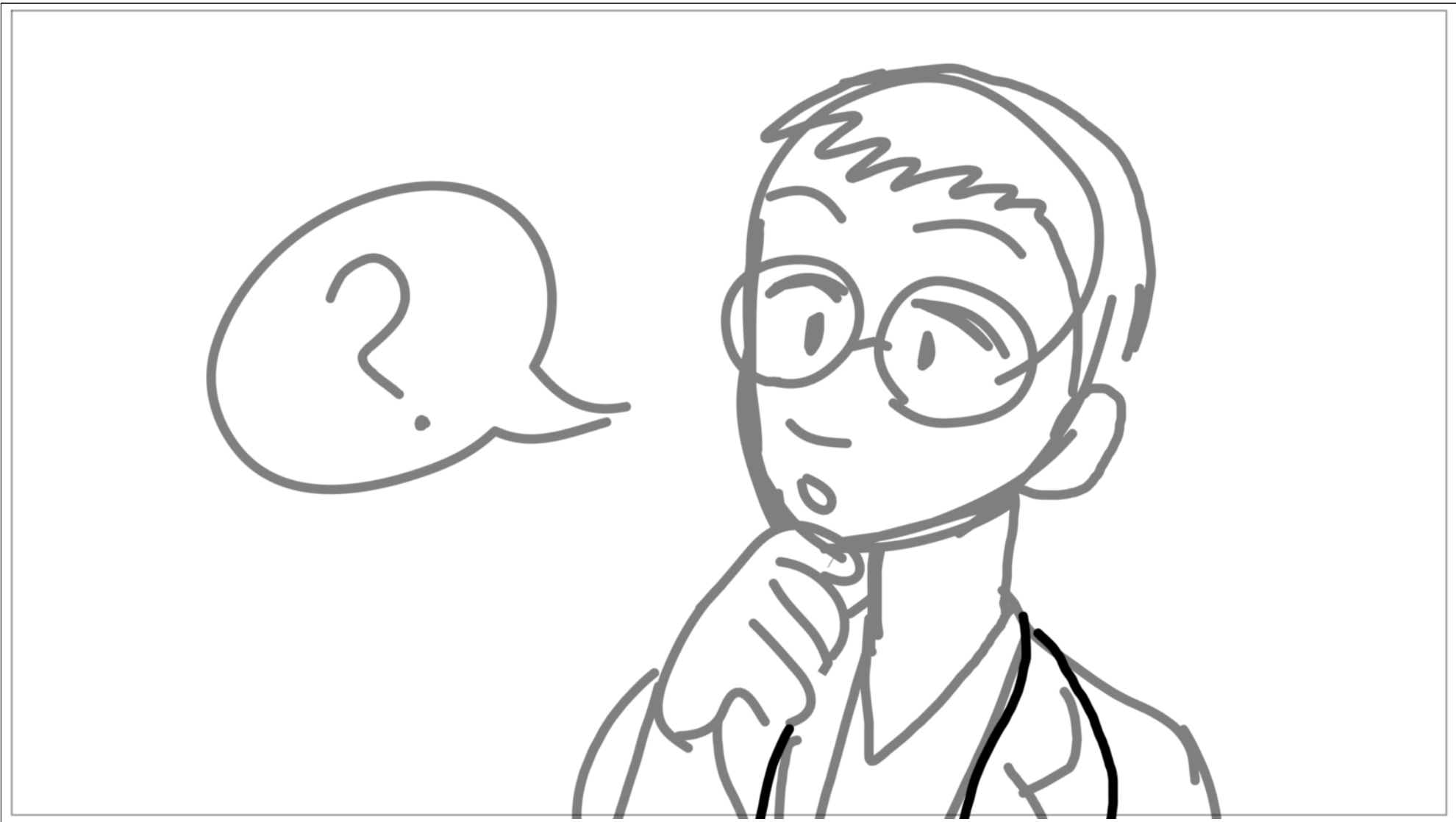

Scene	Duration	Panel	Duration
14_H	02:01	1	01:00



Scene	Duration	Panel	Duration
14_H	02:01	2	01:01



Scene	Duration	Panel	Duration
14_I	01:18	1	00:22



Scene	Duration	Panel	Duration
14_I	01:18	2	00:20

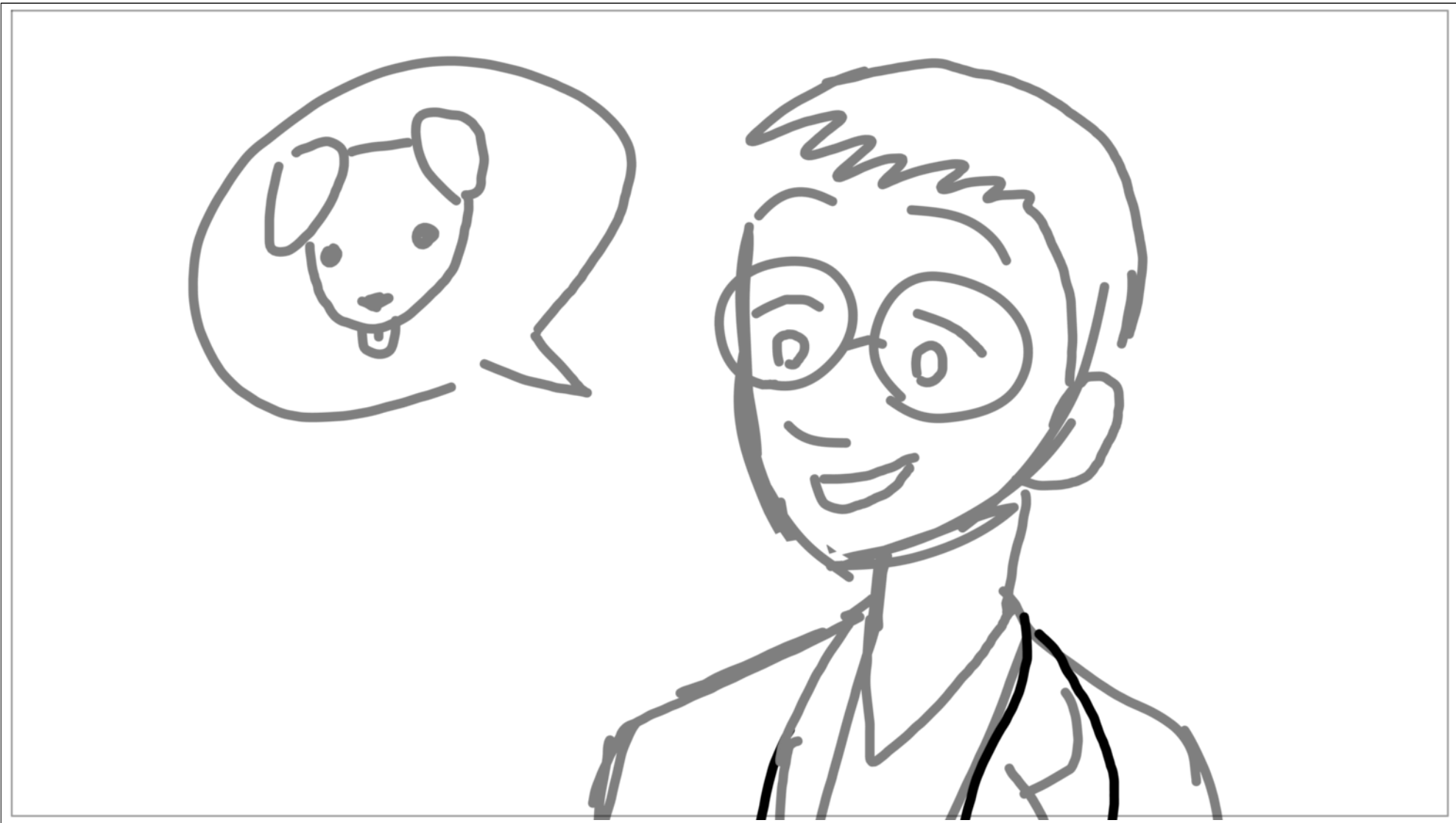

Scene	14_H_1	Duration	01:04	Panel	1	Duration	01:04
-------	--------	----------	-------	-------	---	----------	-------



Scene	14_H_2	Duration	01:05	Panel	1	Duration	00:12
-------	--------	----------	-------	-------	---	----------	-------

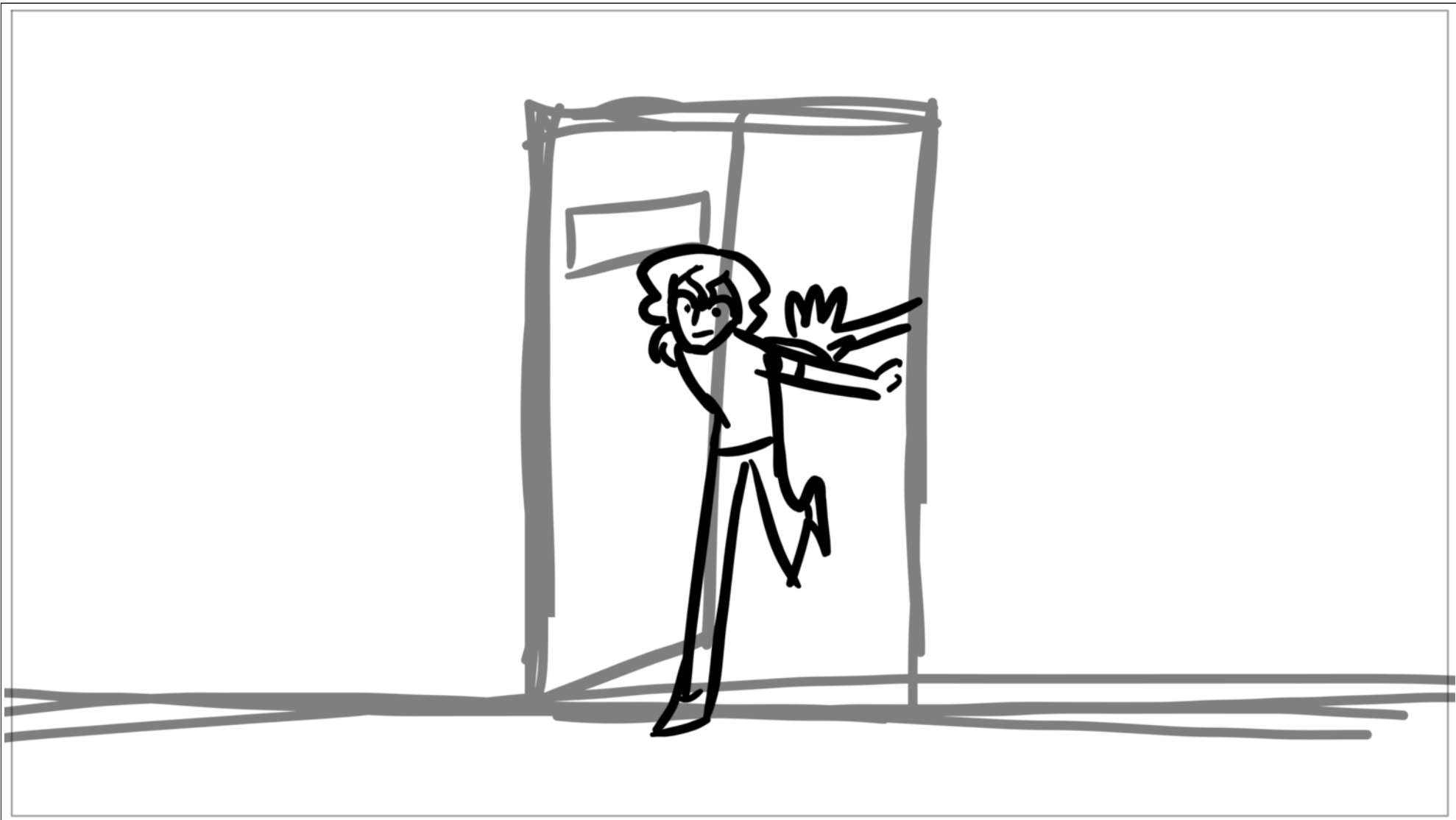

Scene	14_H_2	Duration	01:05	Panel	2	Duration	00:17
-------	--------	----------	-------	-------	---	----------	-------



Scene	14_H_3	Duration	02:10	Panel	1	Duration	00:14
-------	--------	----------	-------	-------	---	----------	-------

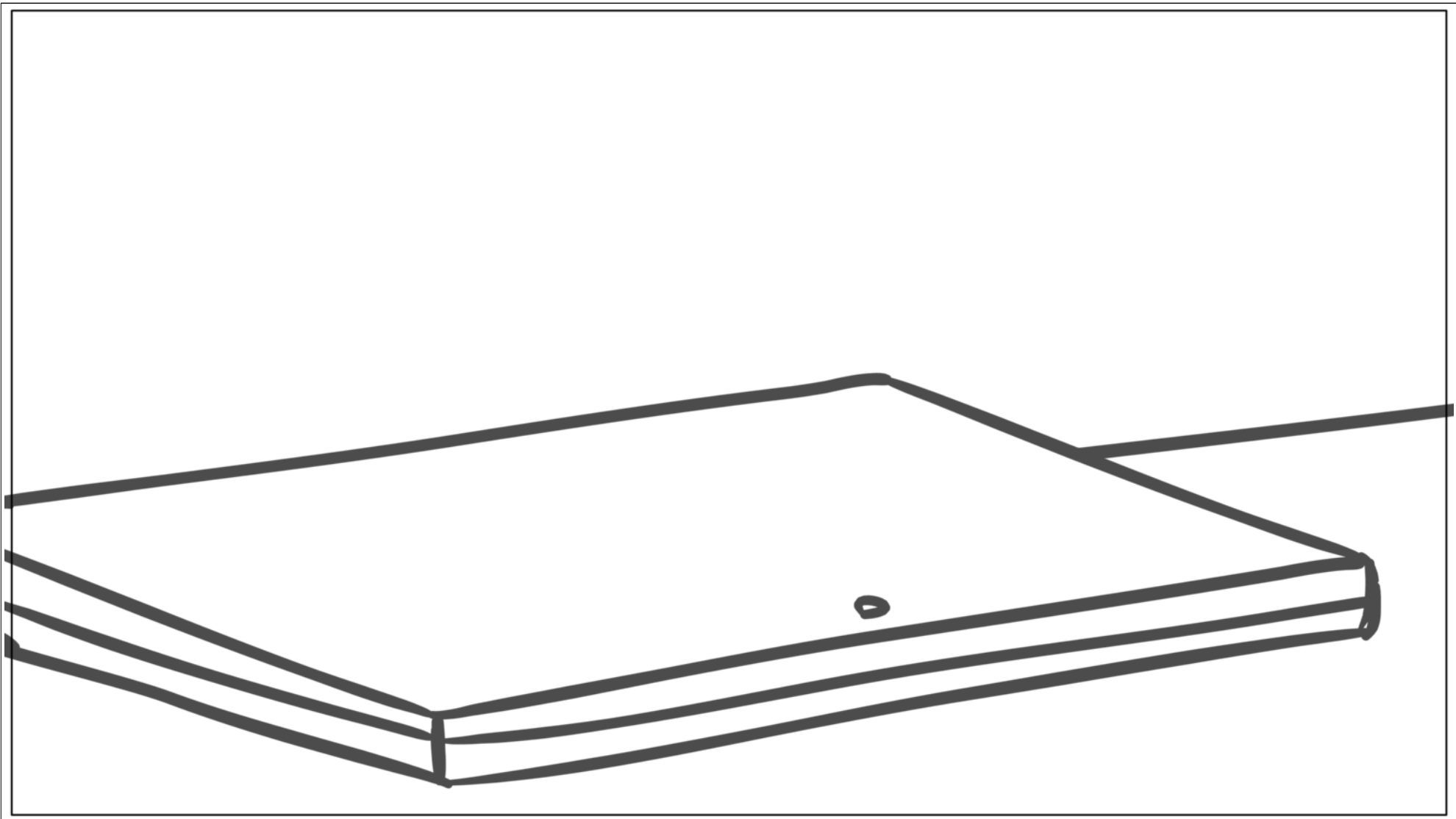

Scene	14_H_3	Duration	02:10	Panel	2	Duration	00:13
-------	--------	----------	-------	-------	---	----------	-------

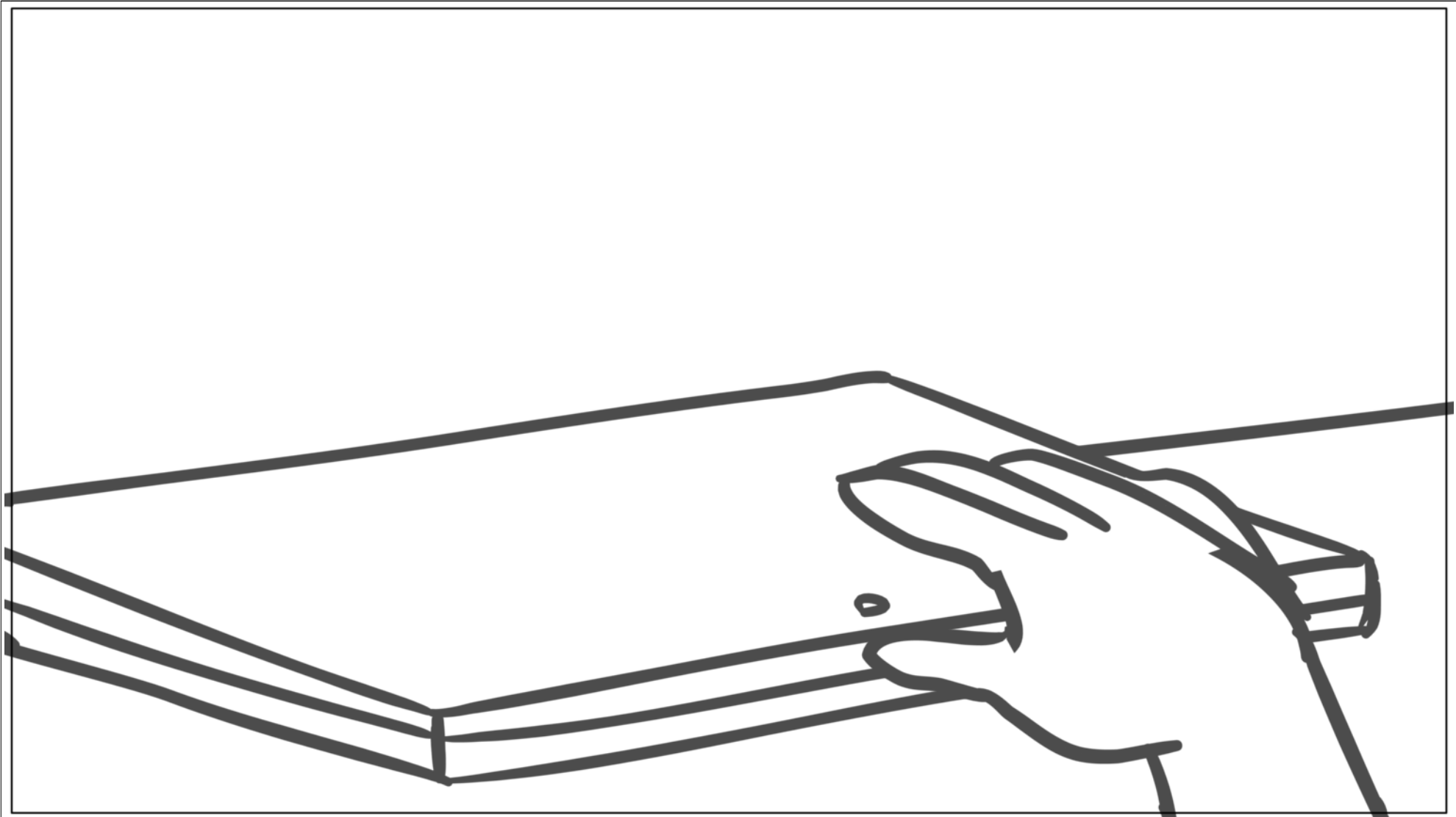

Scene	14_H_3	Duration	02:10	Panel	3	Duration	01:07
-------	--------	----------	-------	-------	---	----------	-------

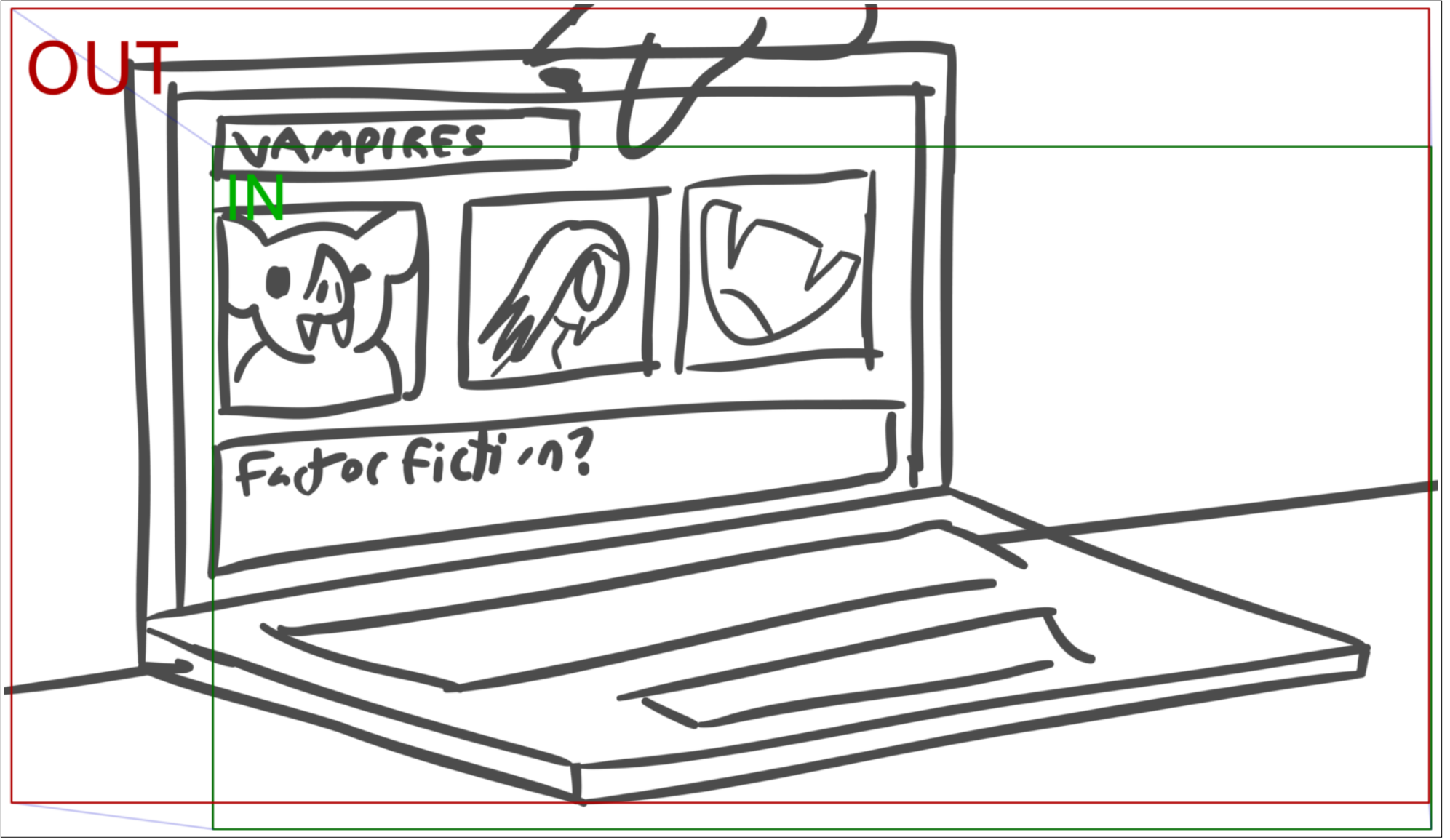

Scene	14_H_4	Duration	02:12	Panel	1	Duration	01:00
-------	--------	----------	-------	-------	---	----------	-------



Scene	14_H_4	Duration	02:12	Panel	2	Duration	01:12
-------	--------	----------	-------	-------	---	----------	-------



Scene	14_H_5	Duration	00:19	Panel	1	Duration	00:19
-------	--------	----------	-------	-------	---	----------	-------

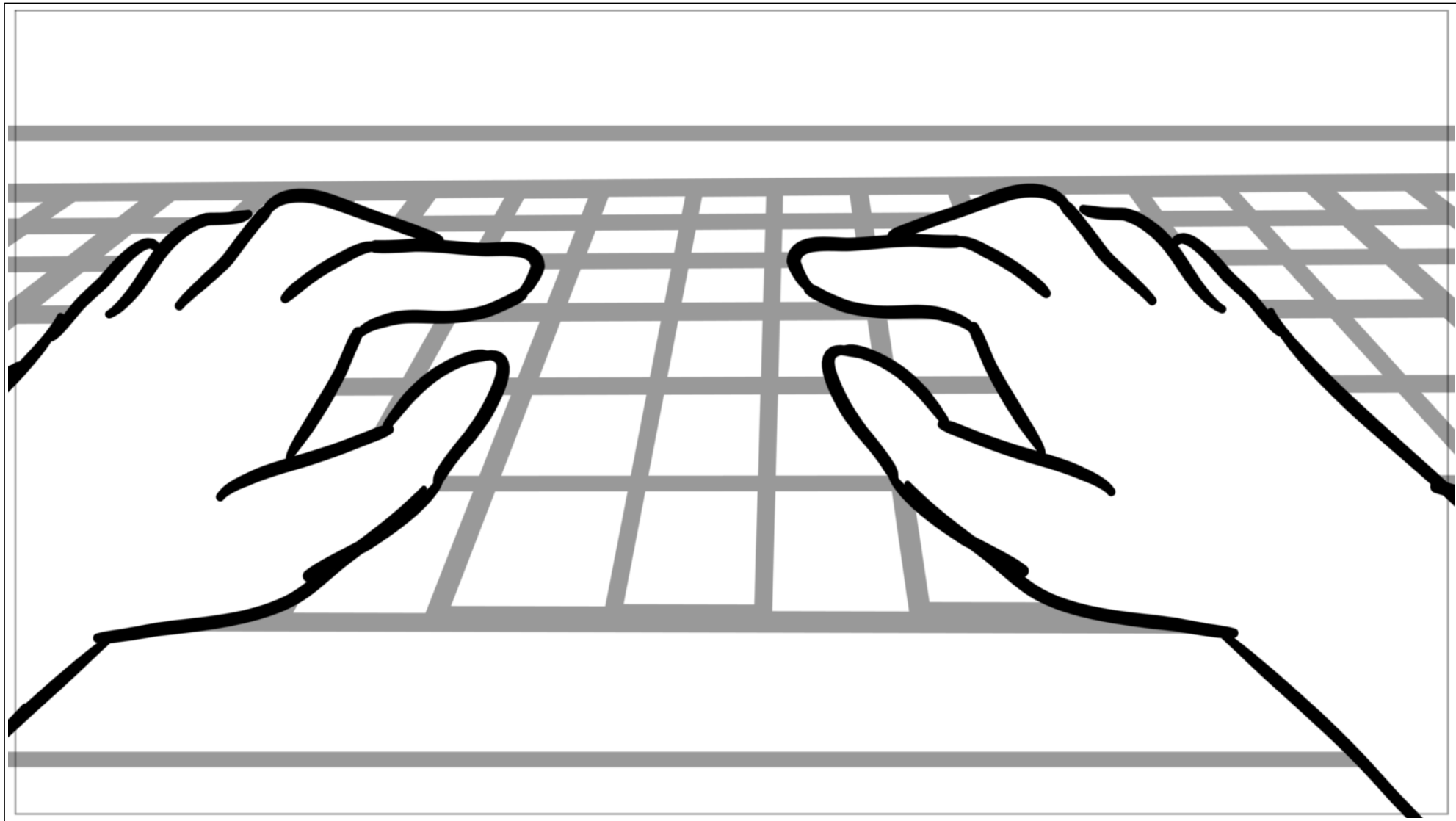

Scene	14_H_6	Duration	03:11	Panel	1	Duration	01:00
-------	--------	----------	-------	-------	---	----------	-------

How to treat a vampire bite?

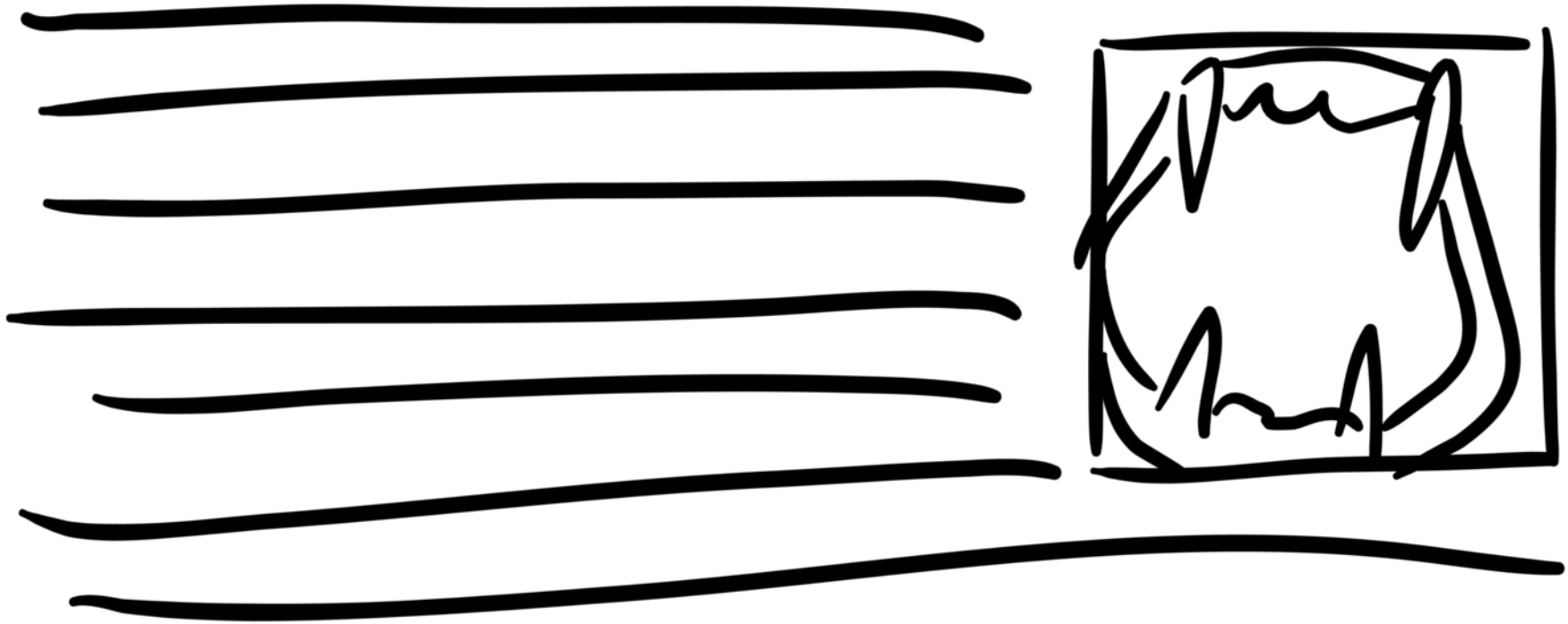

Scene	14_H_6	Duration	03:11	Panel	2	Duration	01:00
-------	--------	----------	-------	-------	---	----------	-------

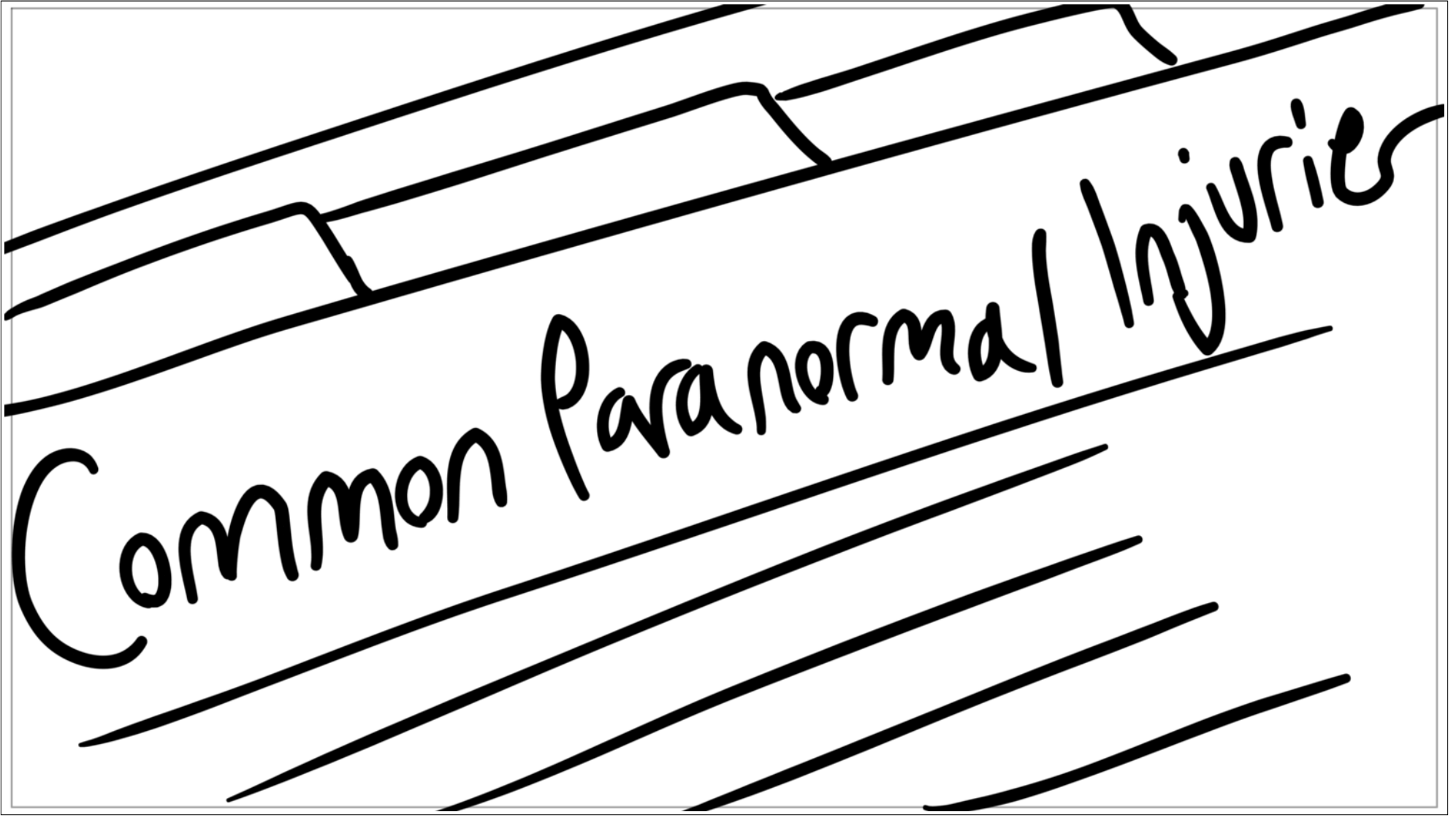

Scene	14_H_6	Duration	03:11	Panel	3	Duration	00:11
-------	--------	----------	-------	-------	---	----------	-------



Scene	Duration	Panel	Duration
14_H_6	03:11	4	01:00

Scars

Scene	Duration	Panel	Duration
14_H_7	01:00	1	01:00



Scene	14_H_8	Duration	04:21	Panel	1	Duration	01:01
-------	--------	----------	-------	-------	---	----------	-------

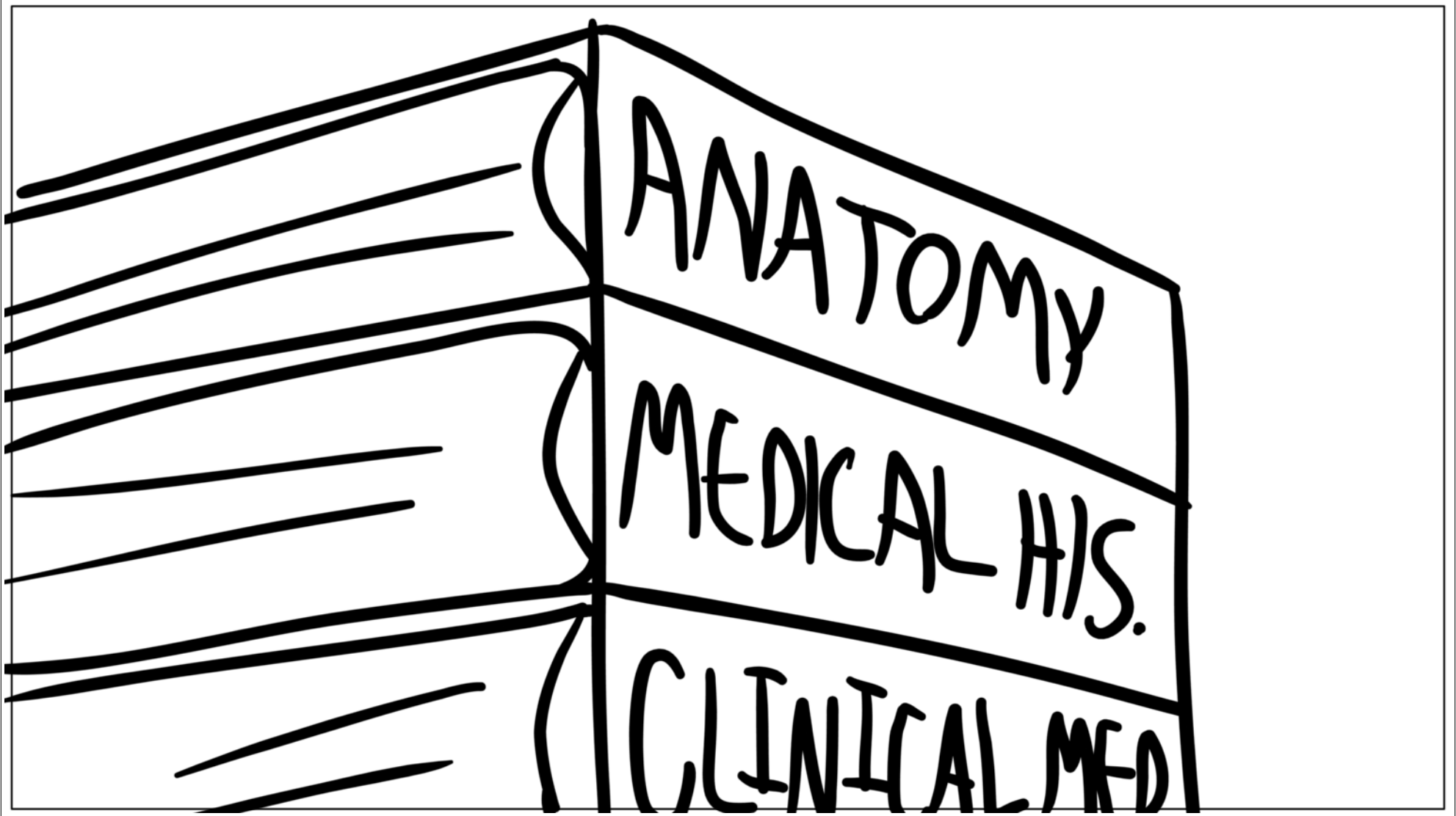

Scene	14_H_8	Duration	04:21	Panel	2	Duration	00:20
-------	--------	----------	-------	-------	---	----------	-------

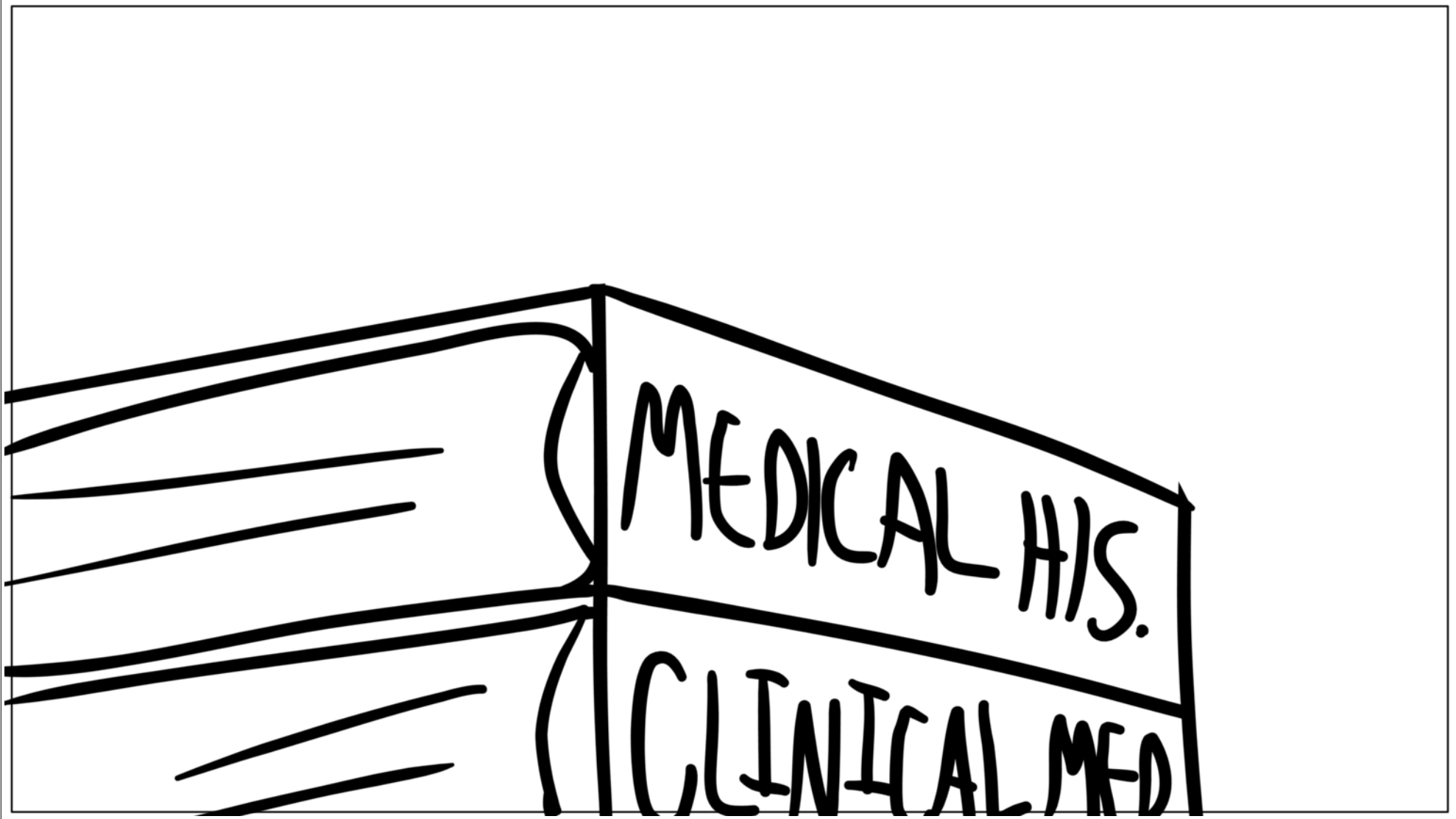

Scene	Duration	Panel	Duration
14_H_8	04:21	3	01:00

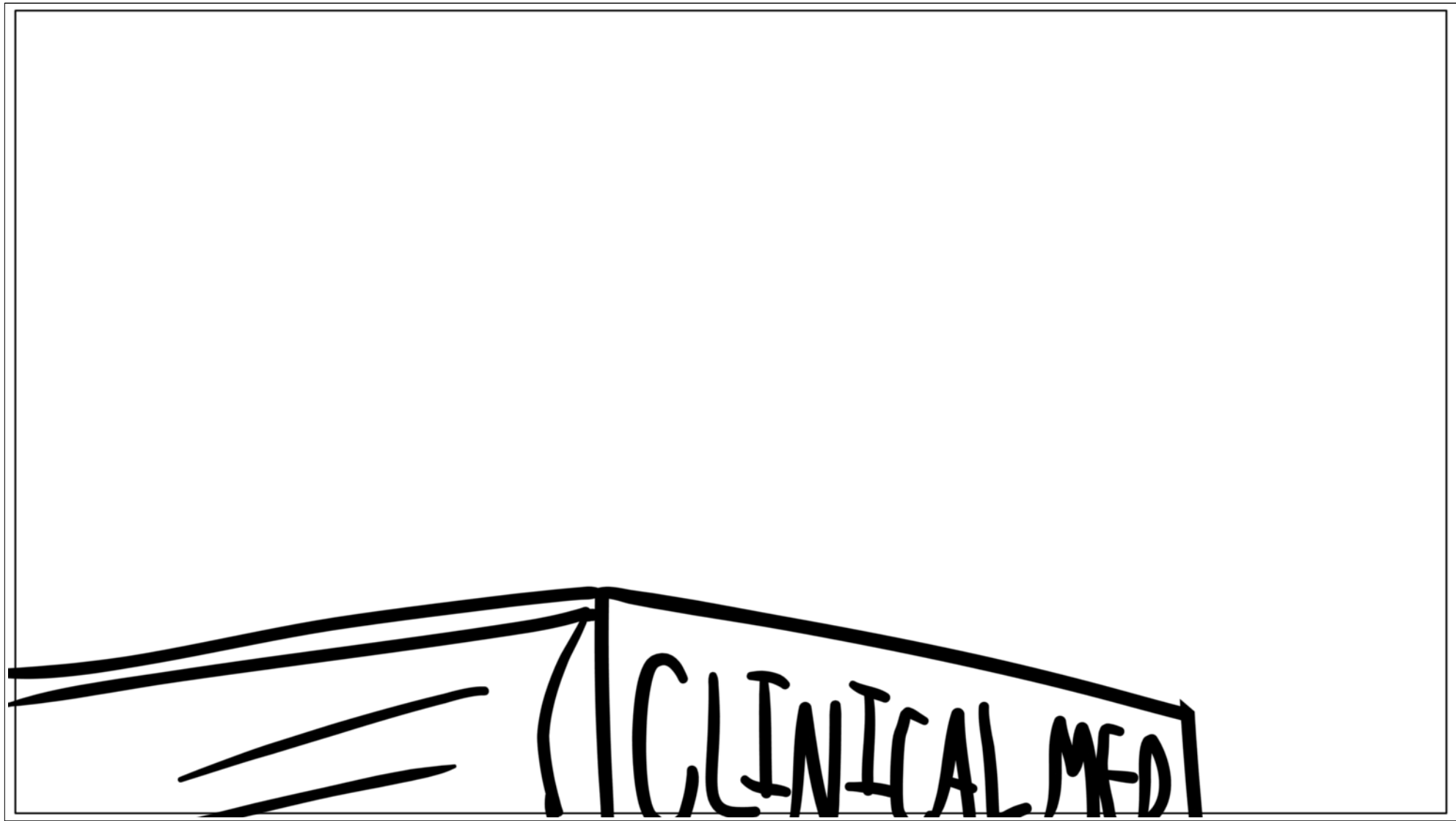

Scene	14_H_8	Duration	04:21	Panel	4	Duration	01:00
-------	--------	----------	-------	-------	---	----------	-------

IN

OUT

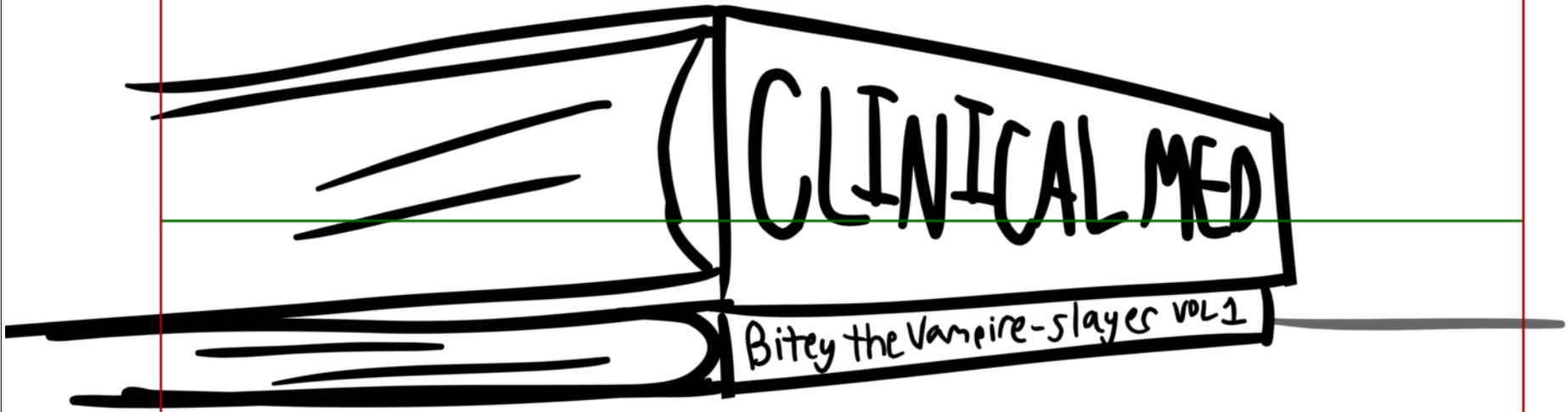

Scene	14_H_8	Duration	04:21	Panel	5	Duration	01:00
-------	--------	----------	-------	-------	---	----------	-------

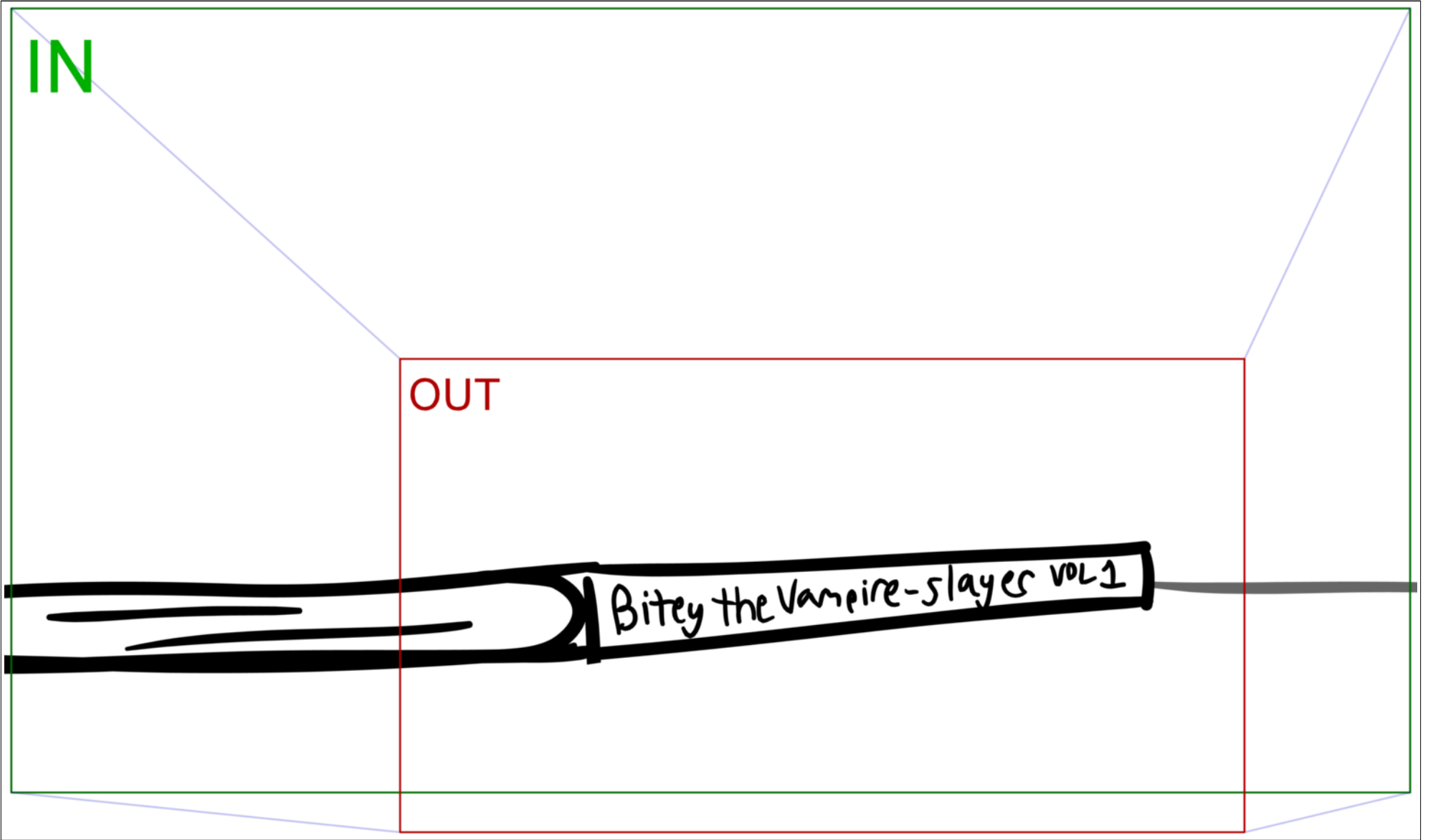

Scene	14_H_9	Duration	03:11	Panel	1	Duration	01:00
-------	--------	----------	-------	-------	---	----------	-------

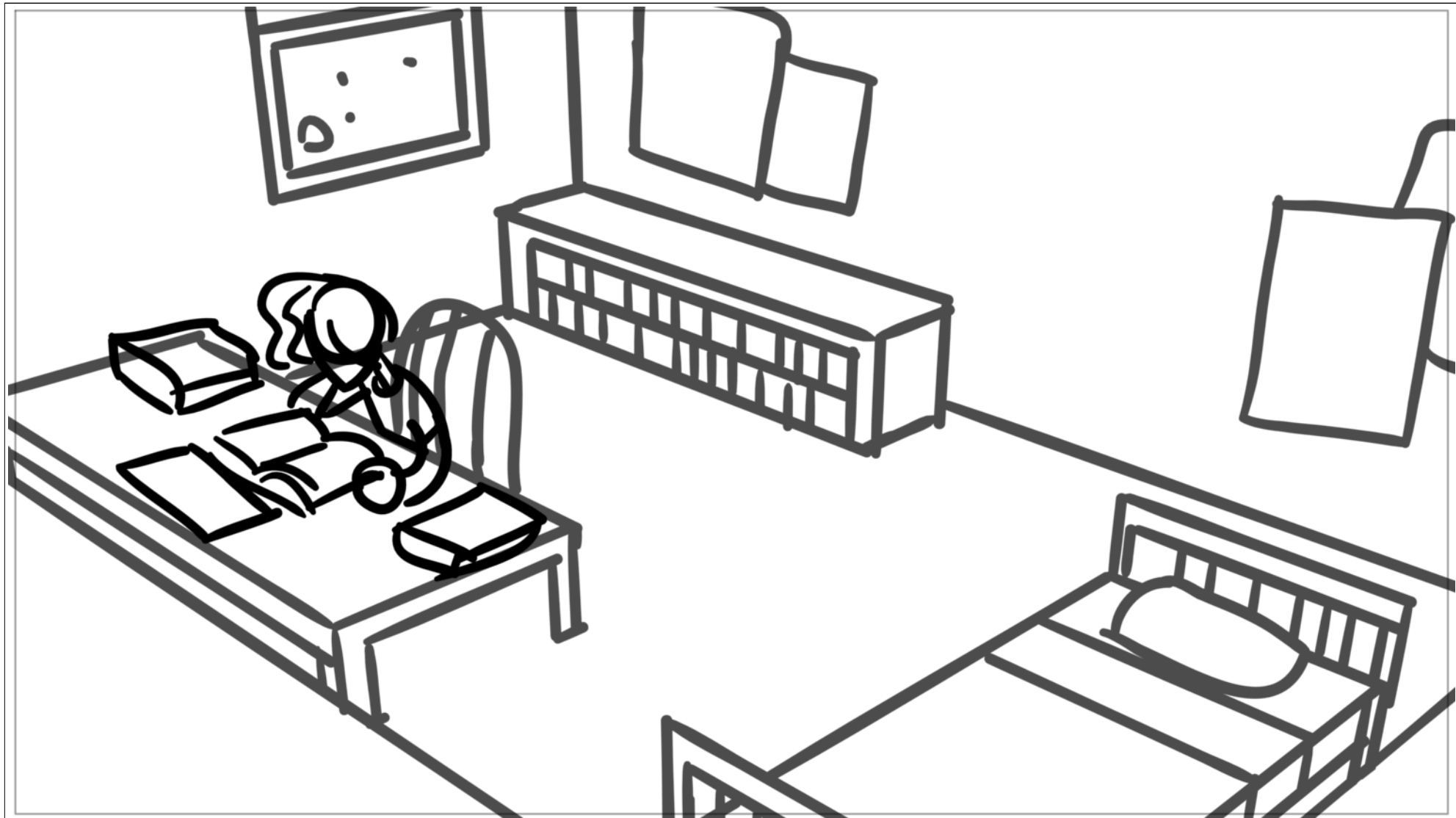

Scene	14_H_9	Duration	03:11	Panel	2	Duration	01:00
-------	--------	----------	-------	-------	---	----------	-------



Scene	14_H_9	Duration	03:11	Panel	3	Duration	01:11
-------	--------	----------	-------	-------	---	----------	-------



Scene	14_H_10	Duration	01:14	Panel	1	Duration	01:14
-------	---------	----------	-------	-------	---	----------	-------



Scene	14_H_11	Duration	01:15	Panel	1	Duration	01:15
-------	---------	----------	-------	-------	---	----------	-------



Scene	14_H_12	Duration	02:00	Panel	1	Duration	01:00
-------	---------	----------	-------	-------	---	----------	-------

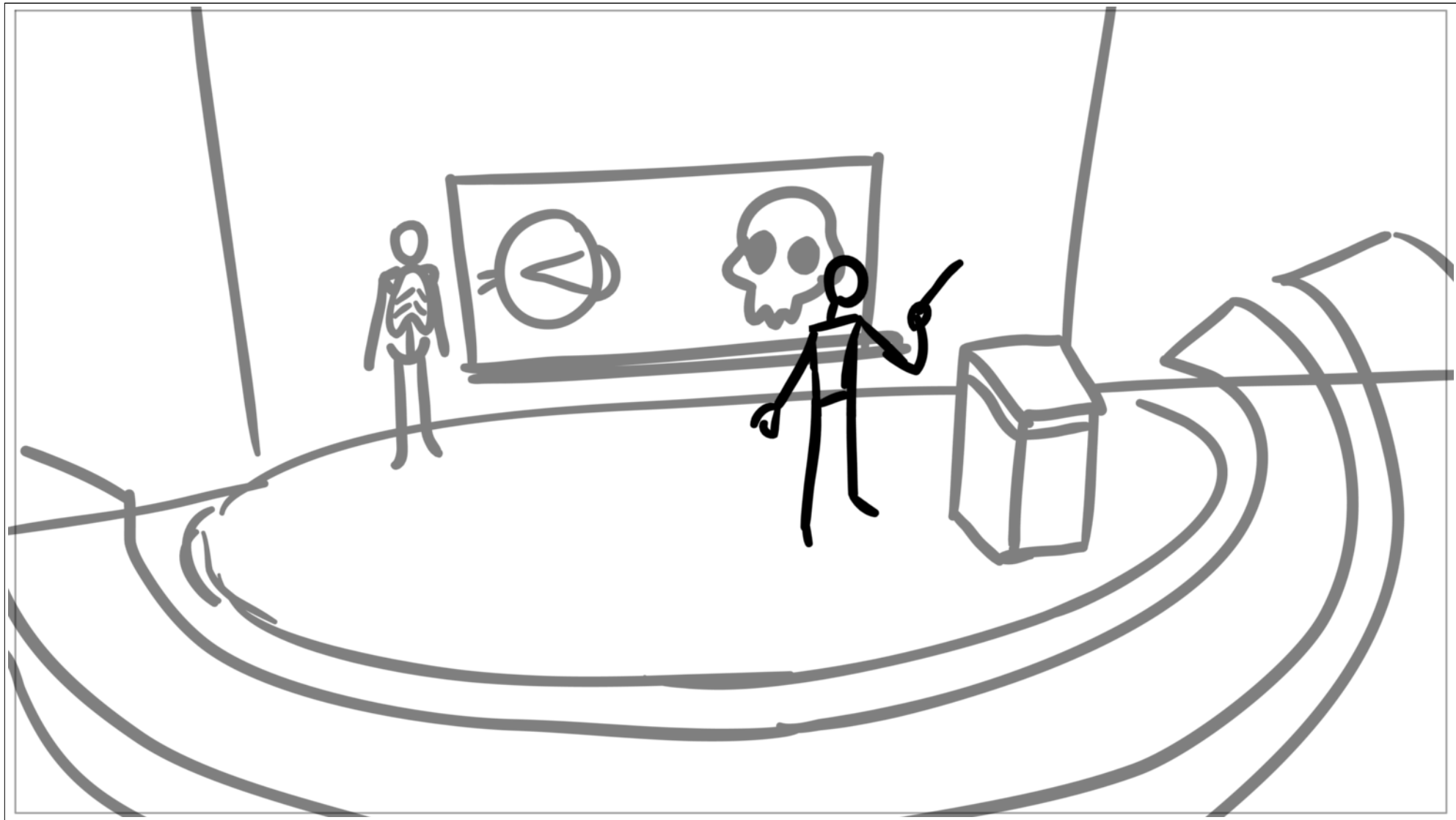

Scene	14_H_12	Duration	02:00	Panel	2	Duration	01:00
-------	---------	----------	-------	-------	---	----------	-------

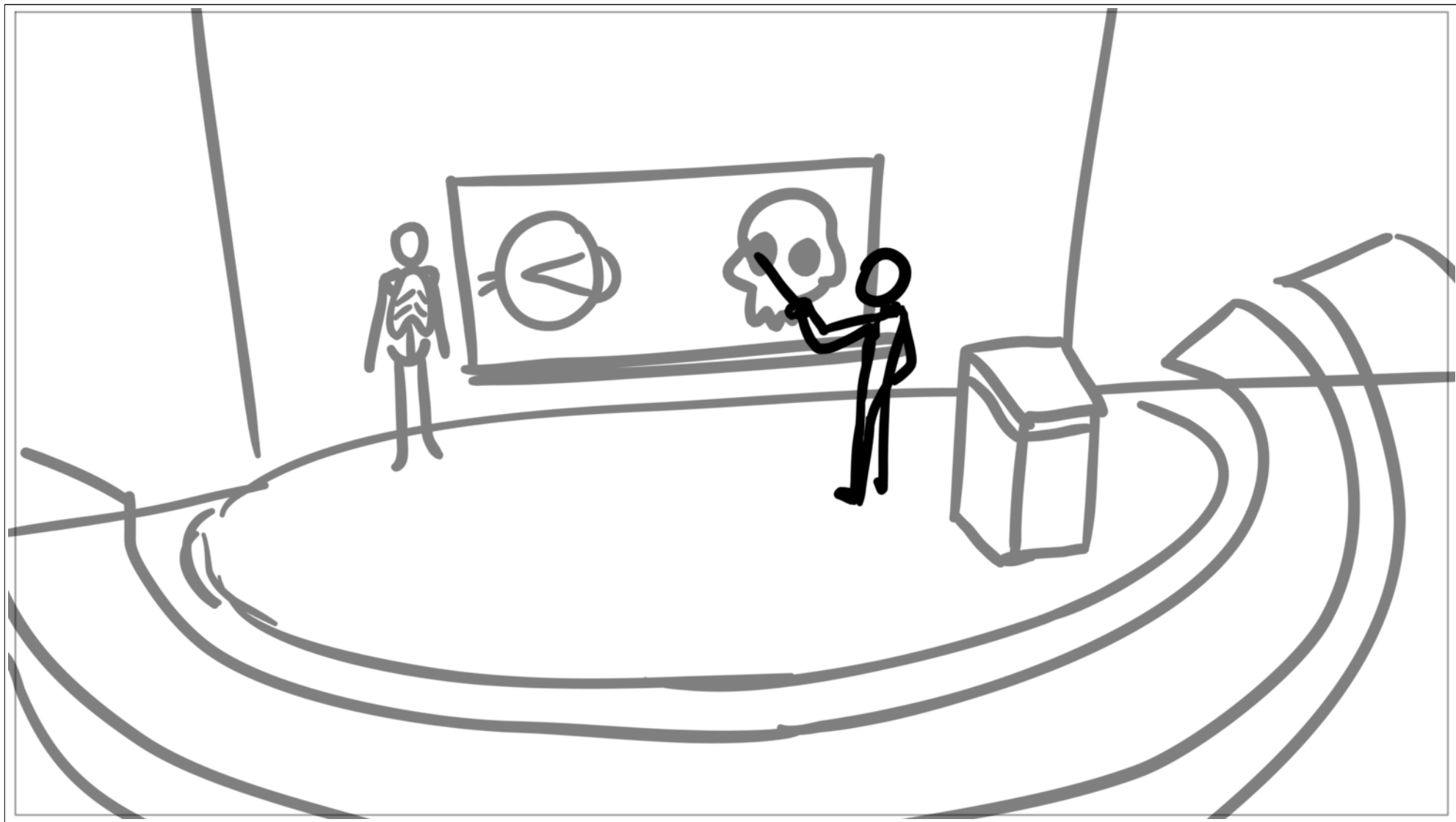

Scene	14_H_13	Duration	02:05	Panel	1	Duration	01:05
-------	---------	----------	-------	-------	---	----------	-------

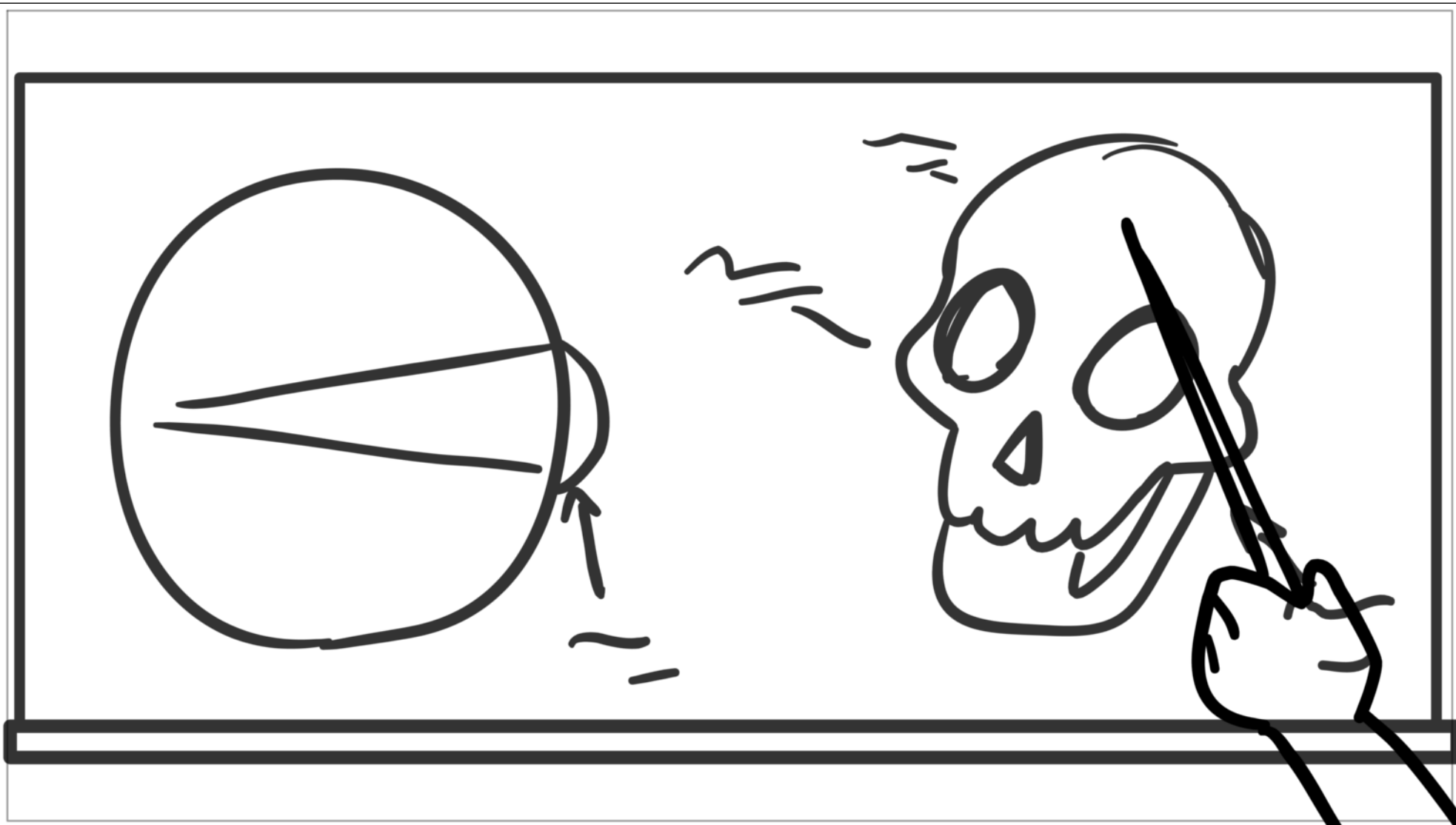

Scene	14_H_13	Duration	02:05	Panel	2	Duration	01:00
-------	---------	----------	-------	-------	---	----------	-------

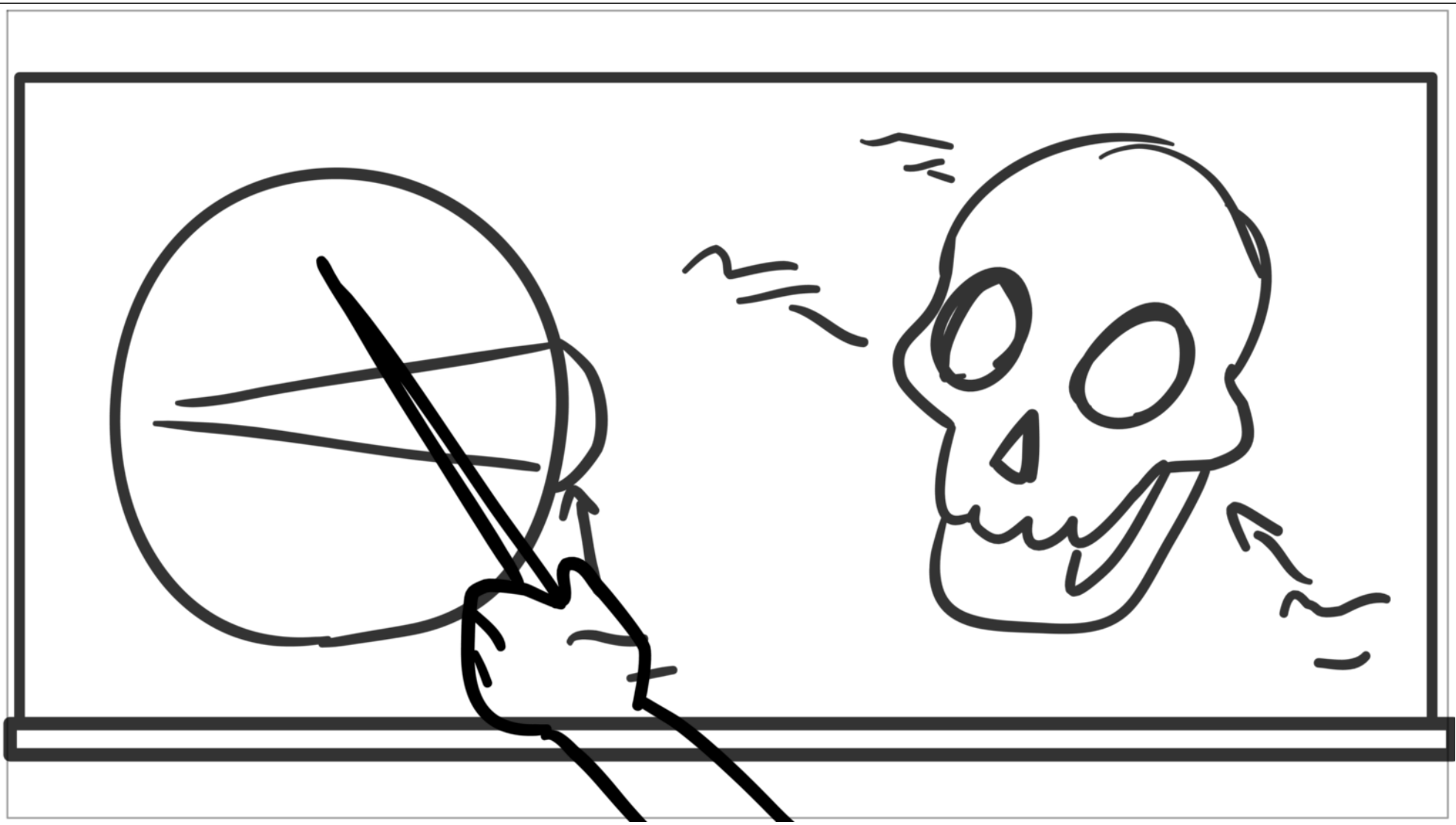

Scene	14_H_11_A	Duration	02:12	Panel	1	Duration	00:21
-------	-----------	----------	-------	-------	---	----------	-------

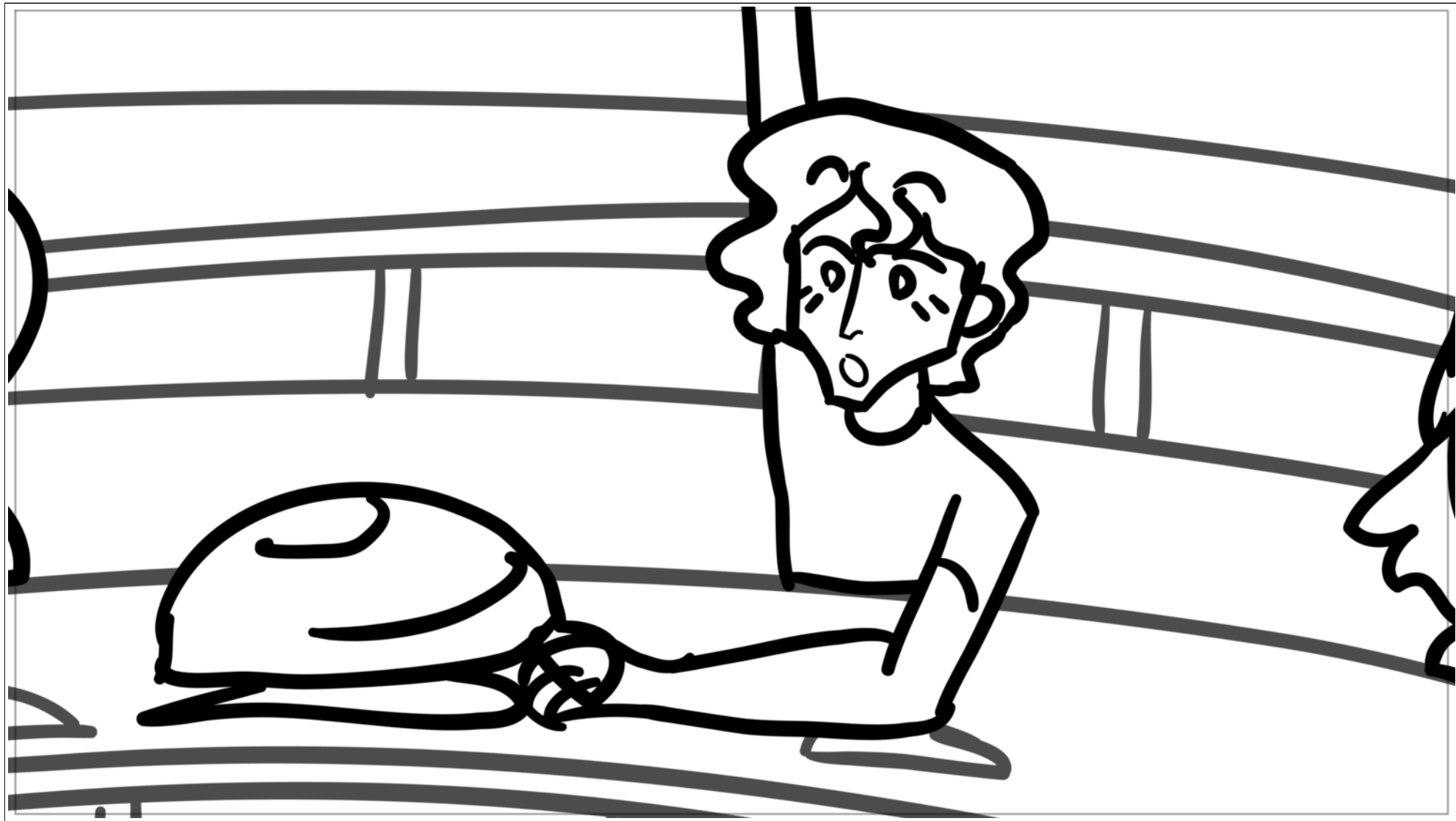

Scene	14_H_11_A	Duration	02:12	Panel	2	Duration	01:15
-------	-----------	----------	-------	-------	---	----------	-------

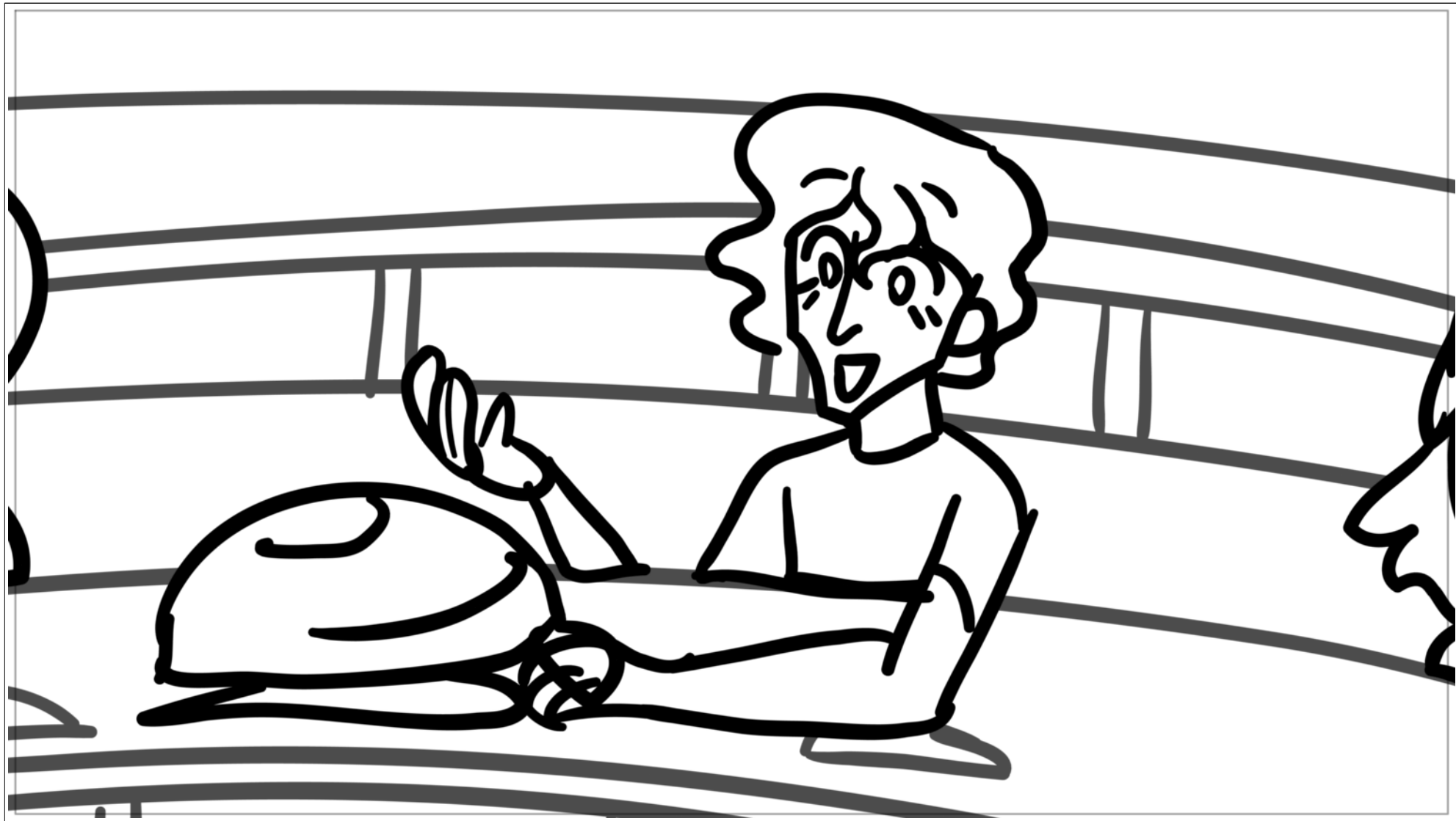

Scene	14_H_11_B	Duration	03:00	Panel	1	Duration	01:00
-------	-----------	----------	-------	-------	---	----------	-------

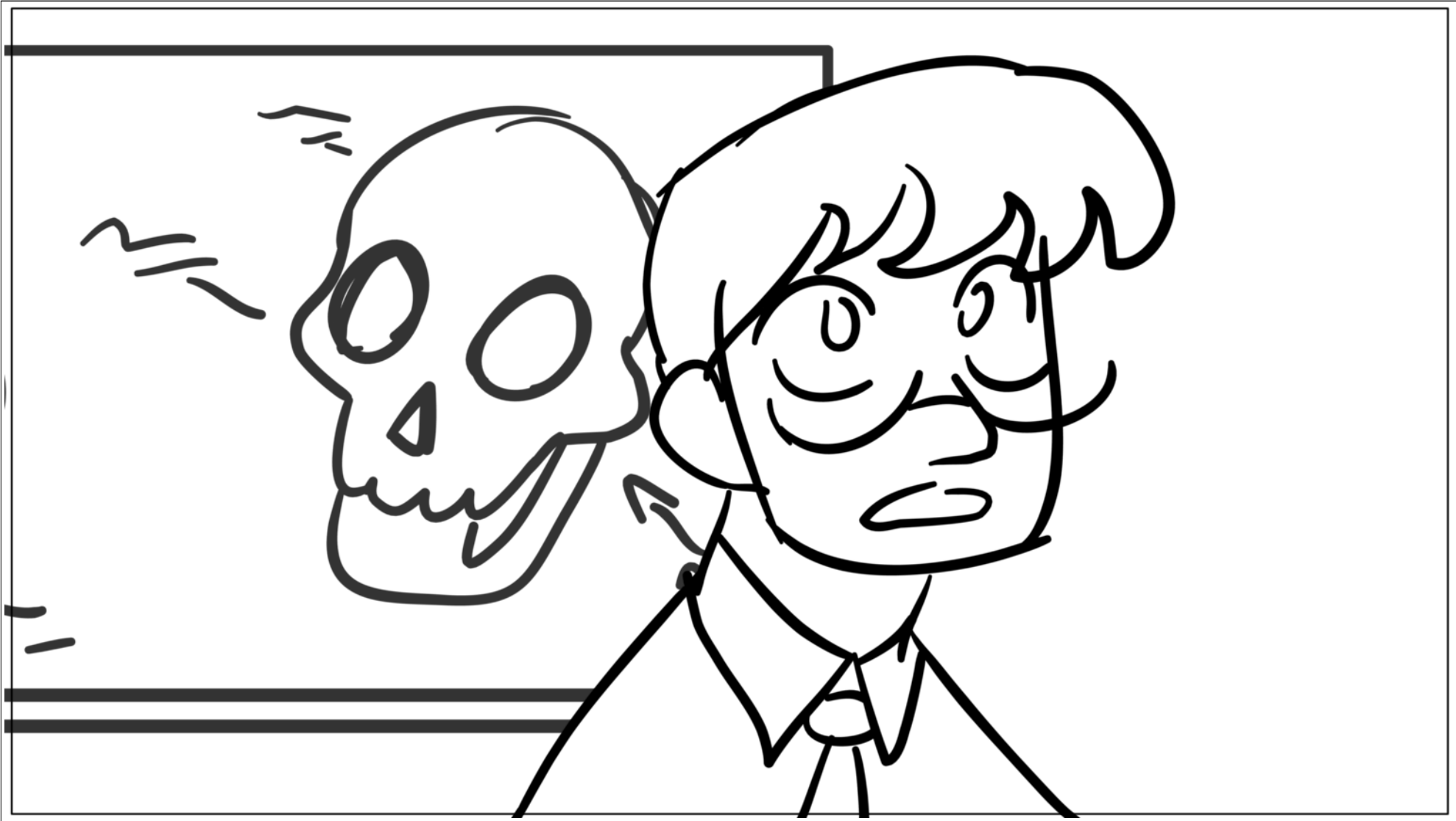

Scene	14_H_11_B	Duration	03:00	Panel	2	Duration	01:00
-------	-----------	----------	-------	-------	---	----------	-------

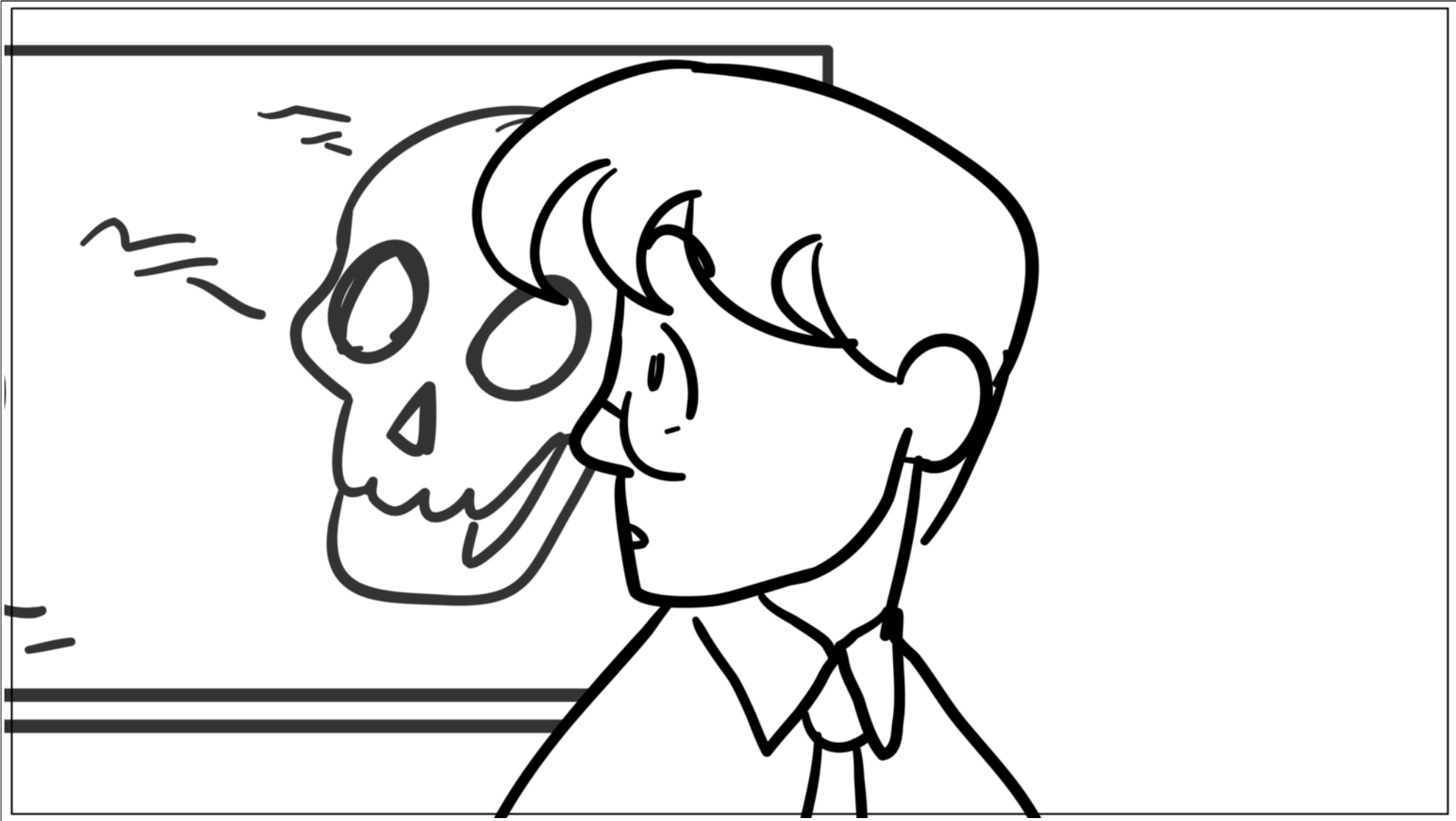

Scene	14_H_11_B	Duration	03:00	Panel	3	Duration	01:00
-------	-----------	----------	-------	-------	---	----------	-------



Scene	Duration	Panel	Duration
14_H_11_B_1	01:00	1	01:00

Years later...

Scene	14_H_11_C	Duration	03:17	Panel	1	Duration	01:00
-------	-----------	----------	-------	-------	---	----------	-------

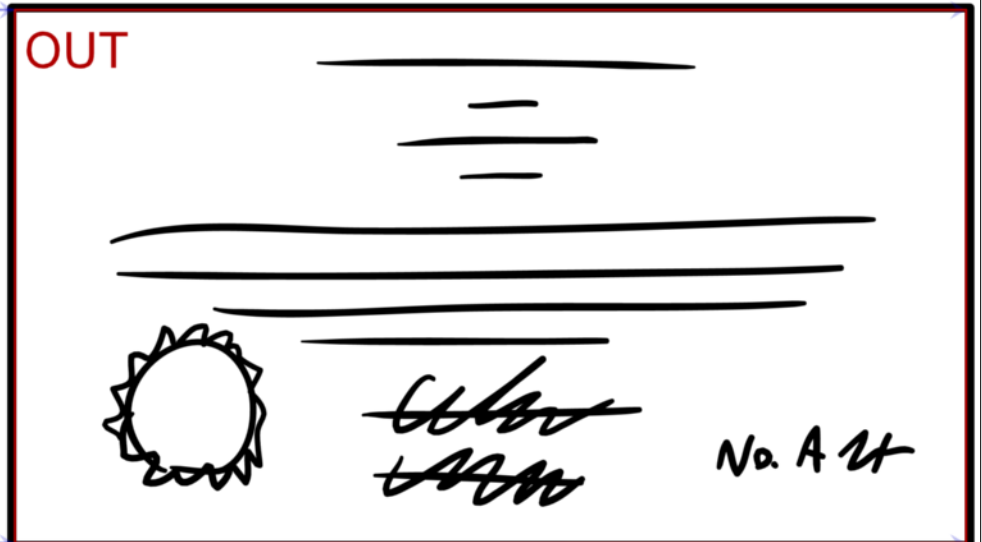
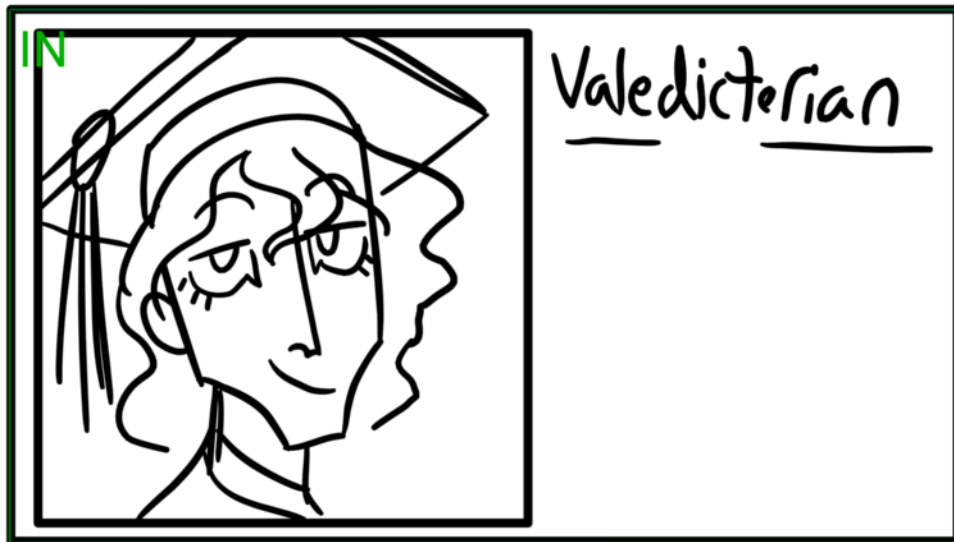

Scene	14_H_11_C	Duration	03:17	Panel	2	Duration	00:17
-------	-----------	----------	-------	-------	---	----------	-------

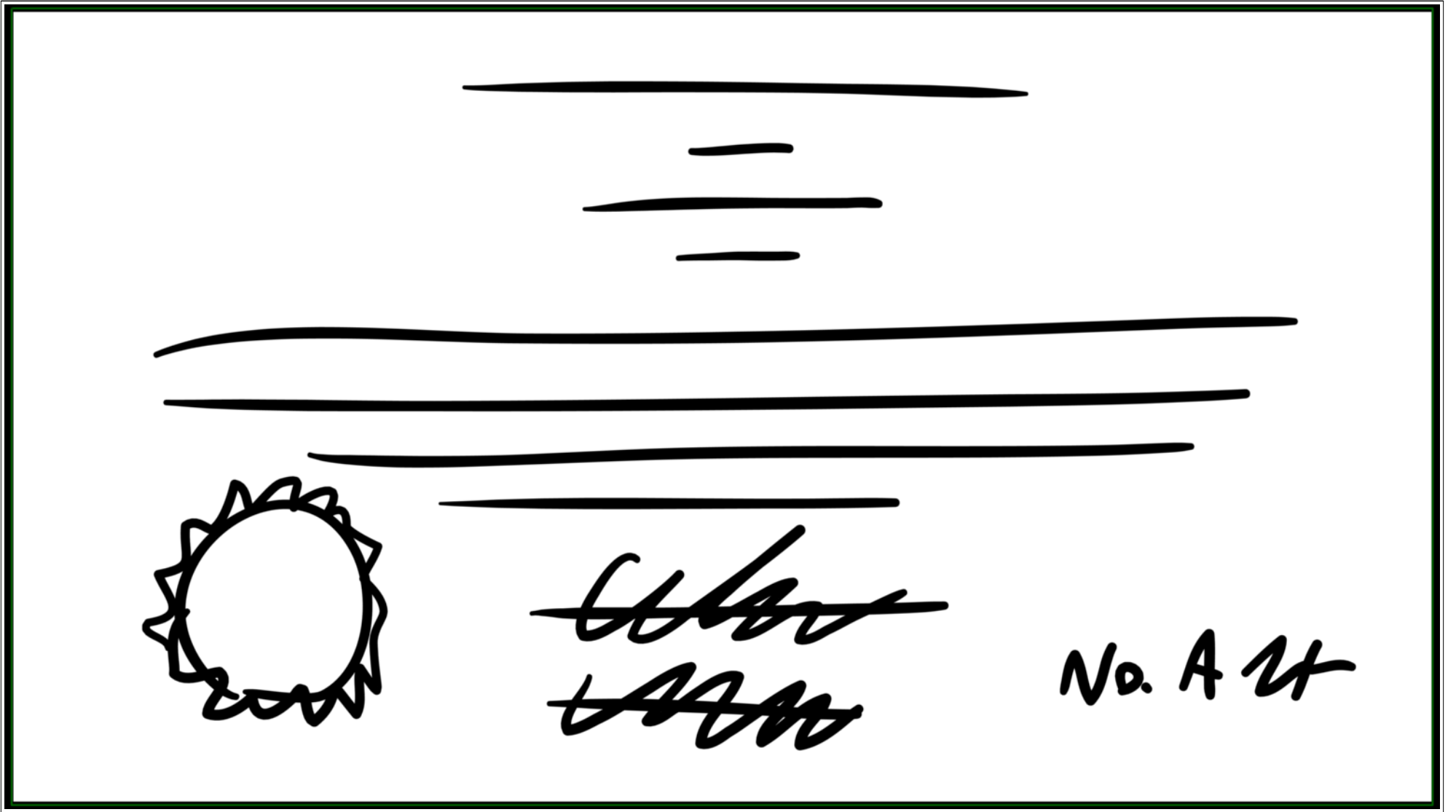

Scene	14_H_11_C	Duration	03:17	Panel	3	Duration	01:00
-------	-----------	----------	-------	-------	---	----------	-------

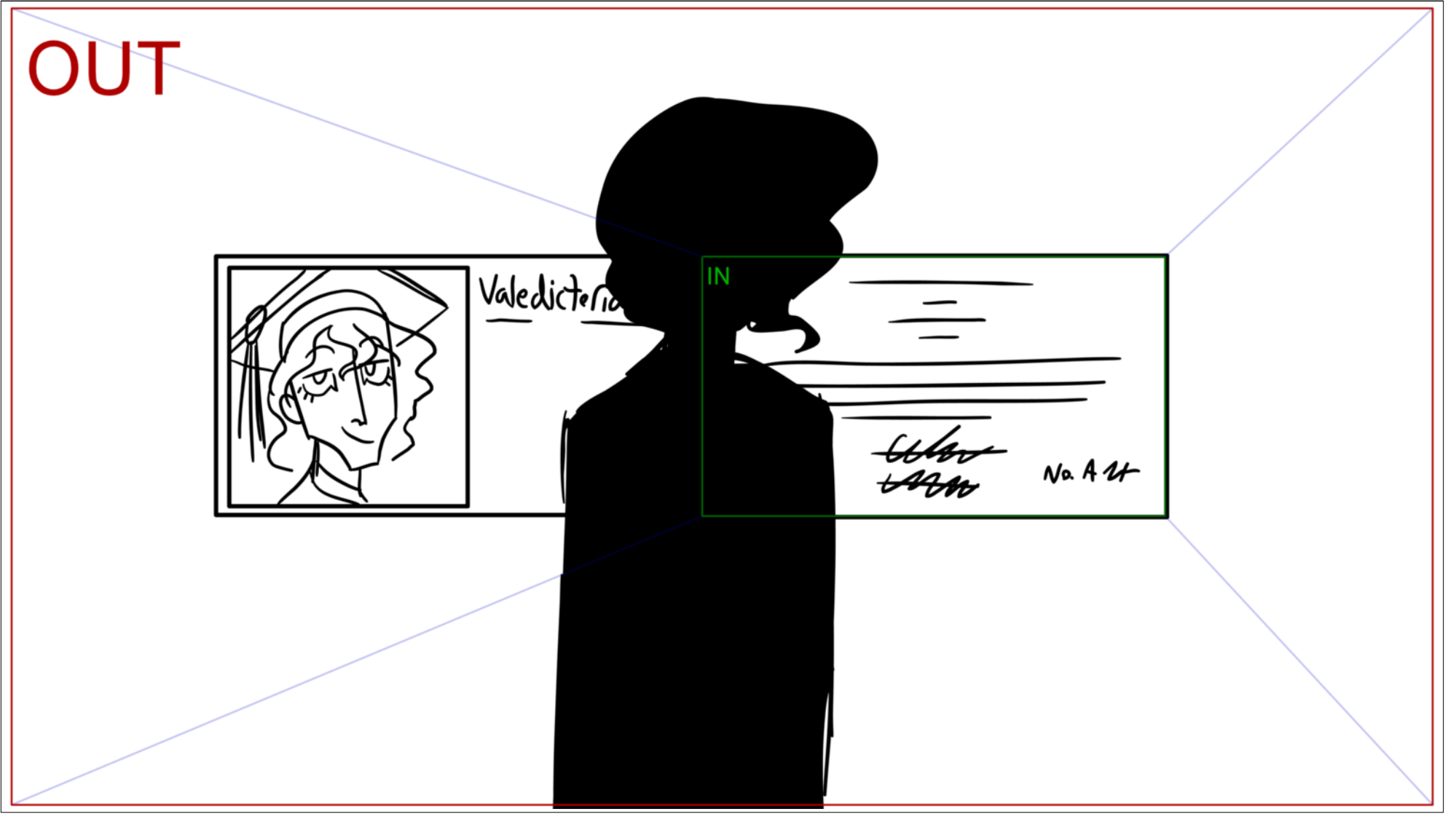

Scene	14_H_11_C	Duration	03:17	Panel	4	Duration	01:00
-------	-----------	----------	-------	-------	---	----------	-------



Scene	14_H_11_D	Duration	02:02	Panel	1	Duration	00:20
-------	-----------	----------	-------	-------	---	----------	-------

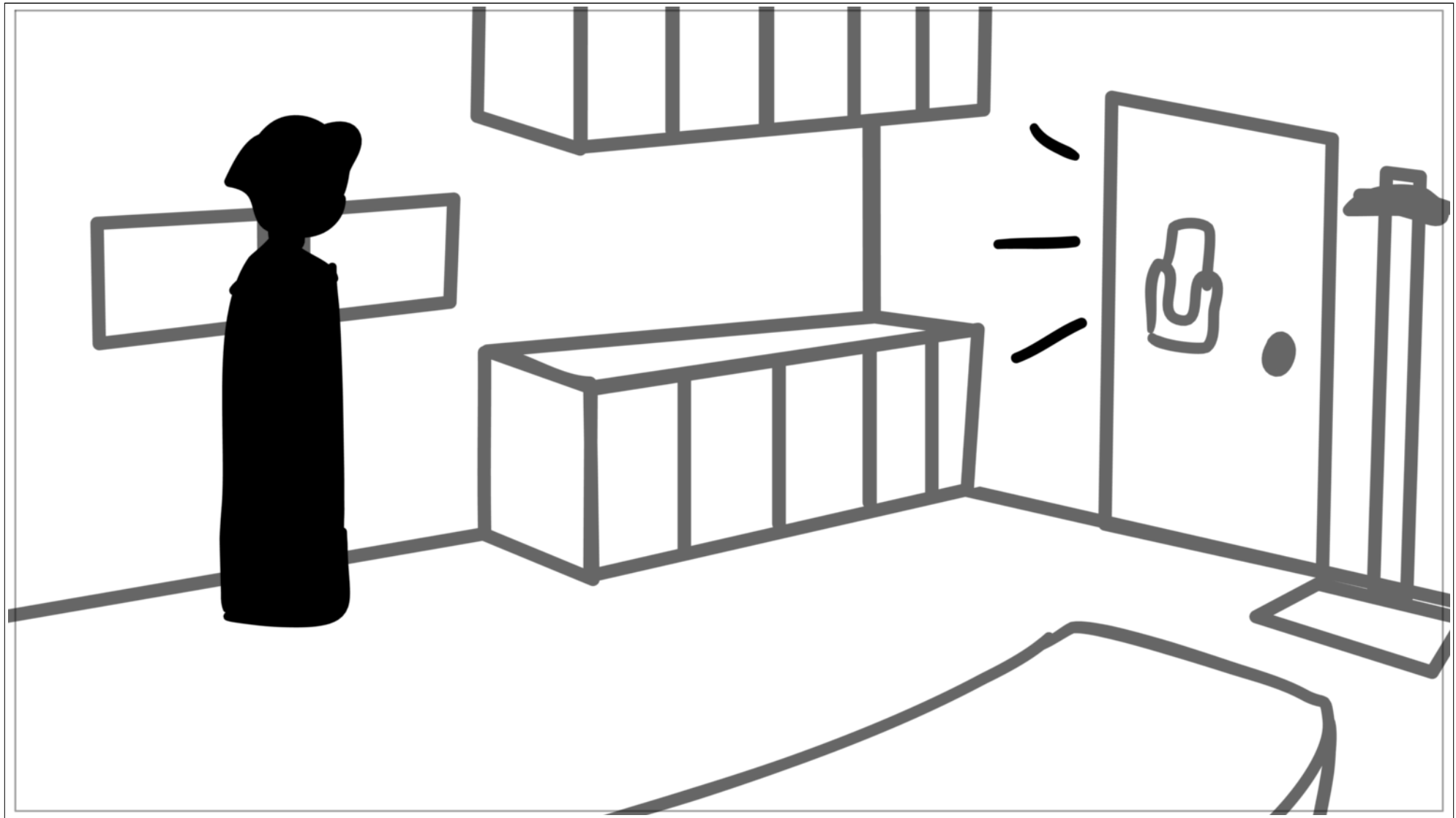

Scene	14_H_11_D	Duration	02:02	Panel	2	Duration	01:06
-------	-----------	----------	-------	-------	---	----------	-------



Scene	14_H_11_E	Duration	01:18	Panel	1	Duration	00:18
-------	-----------	----------	-------	-------	---	----------	-------

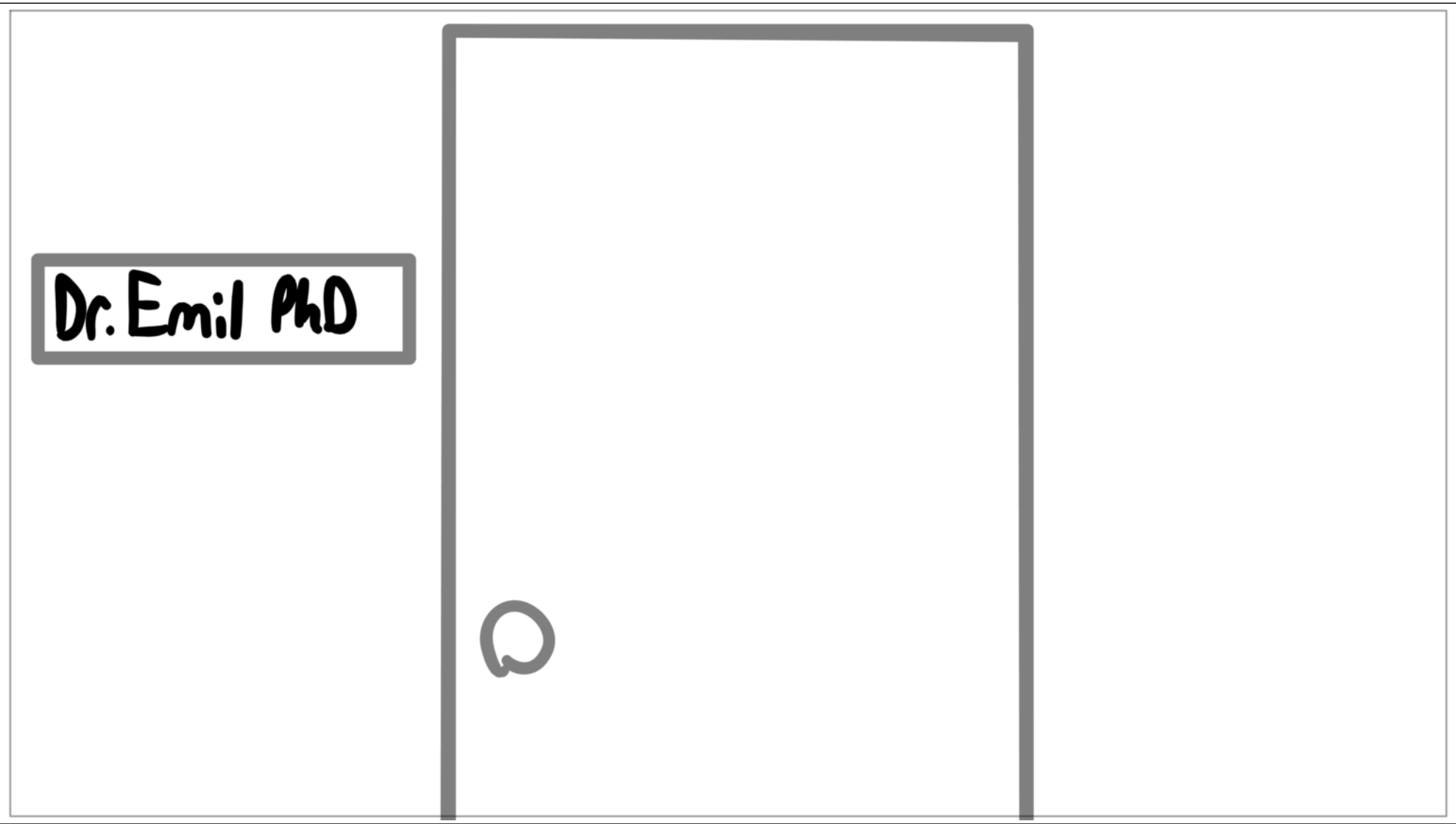

Scene	14_H_11_E	Duration	01:18	Panel	2	Duration	01:00
-------	-----------	----------	-------	-------	---	----------	-------

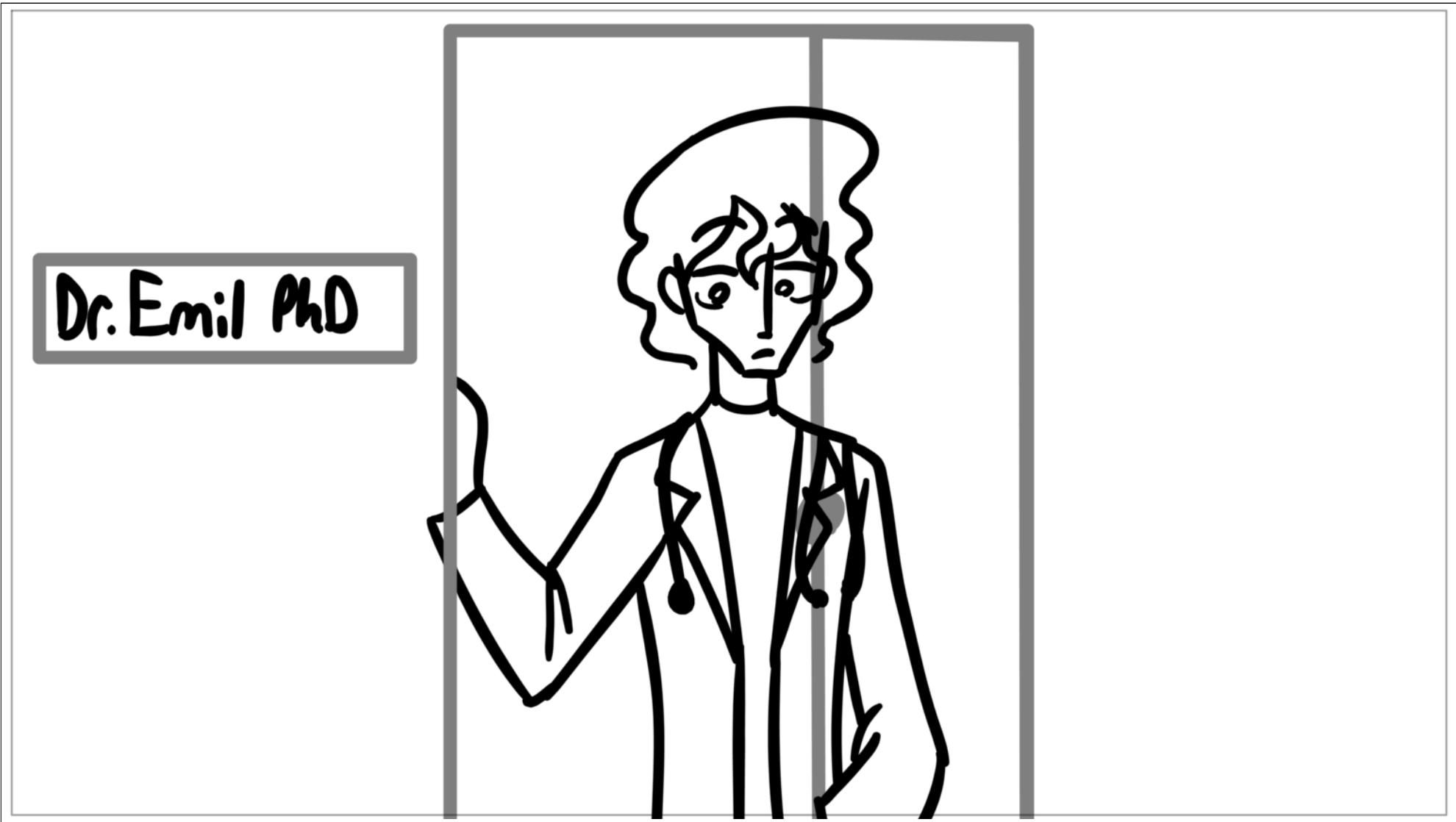

Scene	14_H_11_F	Duration	01:09	Panel	1	Duration	01:09
-------	-----------	----------	-------	-------	---	----------	-------

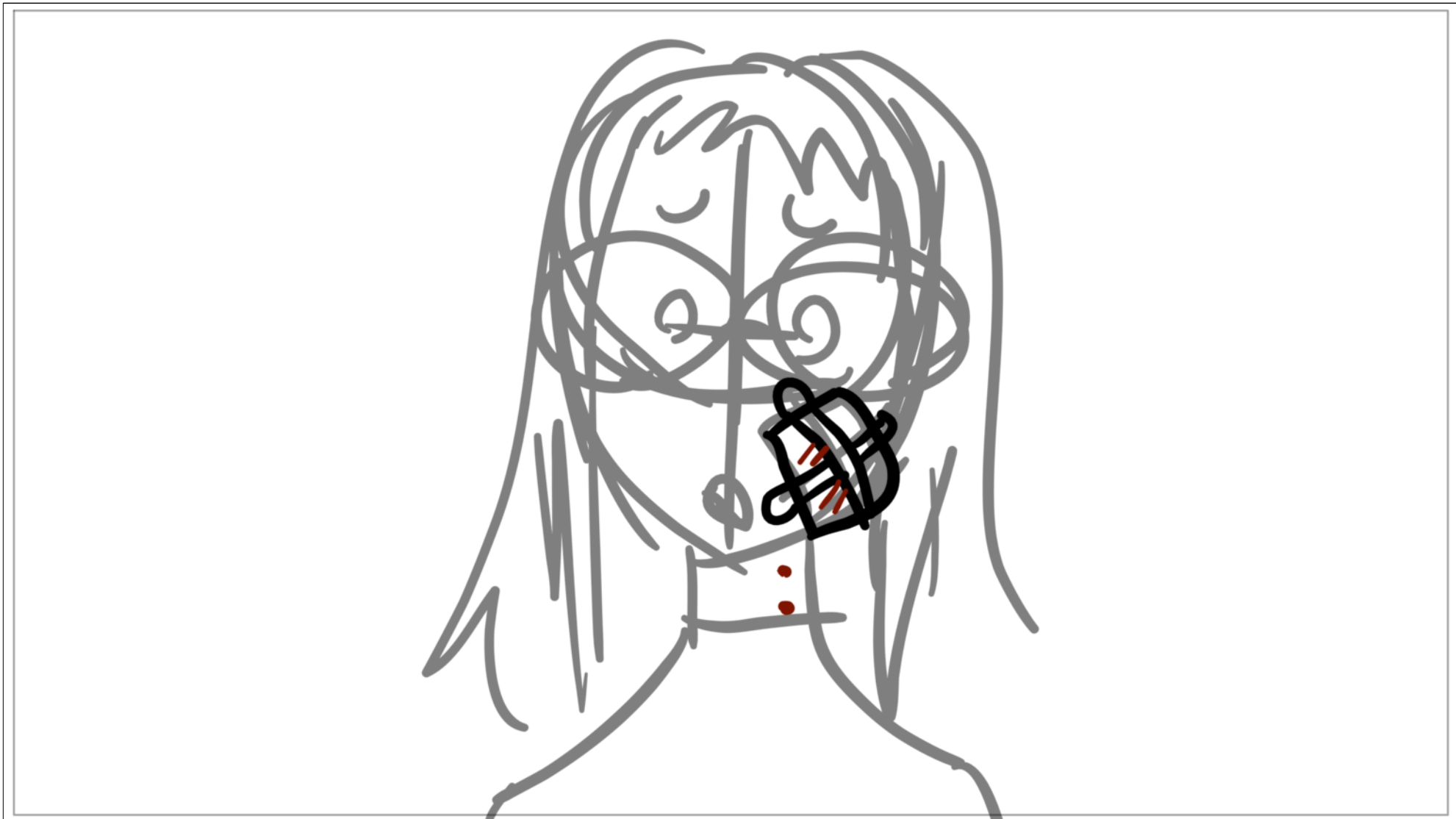

Scene	14_H_11_G	Duration	02:00	Panel	1	Duration	01:00
-------	-----------	----------	-------	-------	---	----------	-------

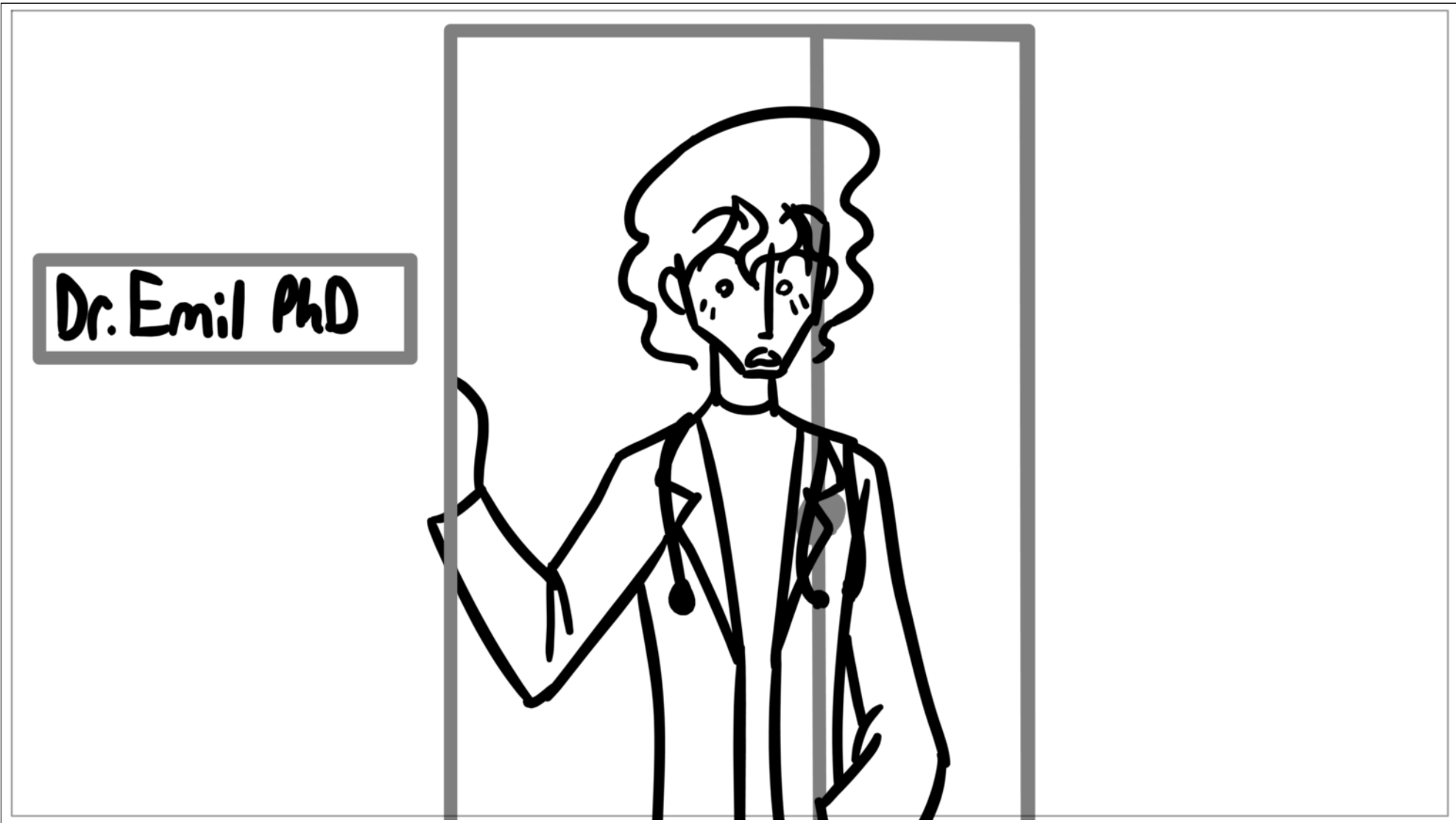

Scene	14_H_11_G	Duration	02:00	Panel	2	Duration	01:00
-------	-----------	----------	-------	-------	---	----------	-------

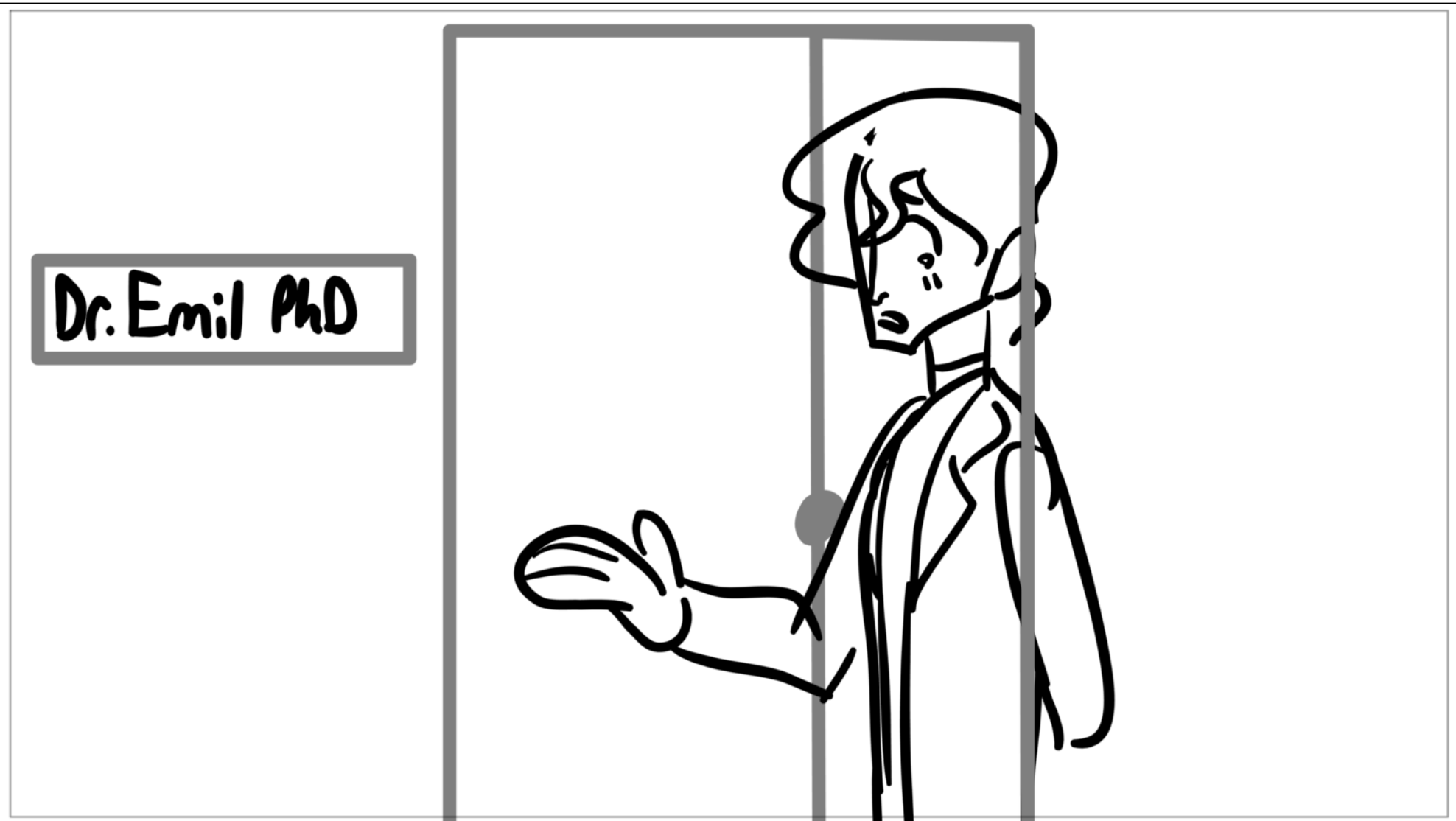

Scene	Duration	Panel	Duration
14_H_11_D_1	02:12	1	01:06

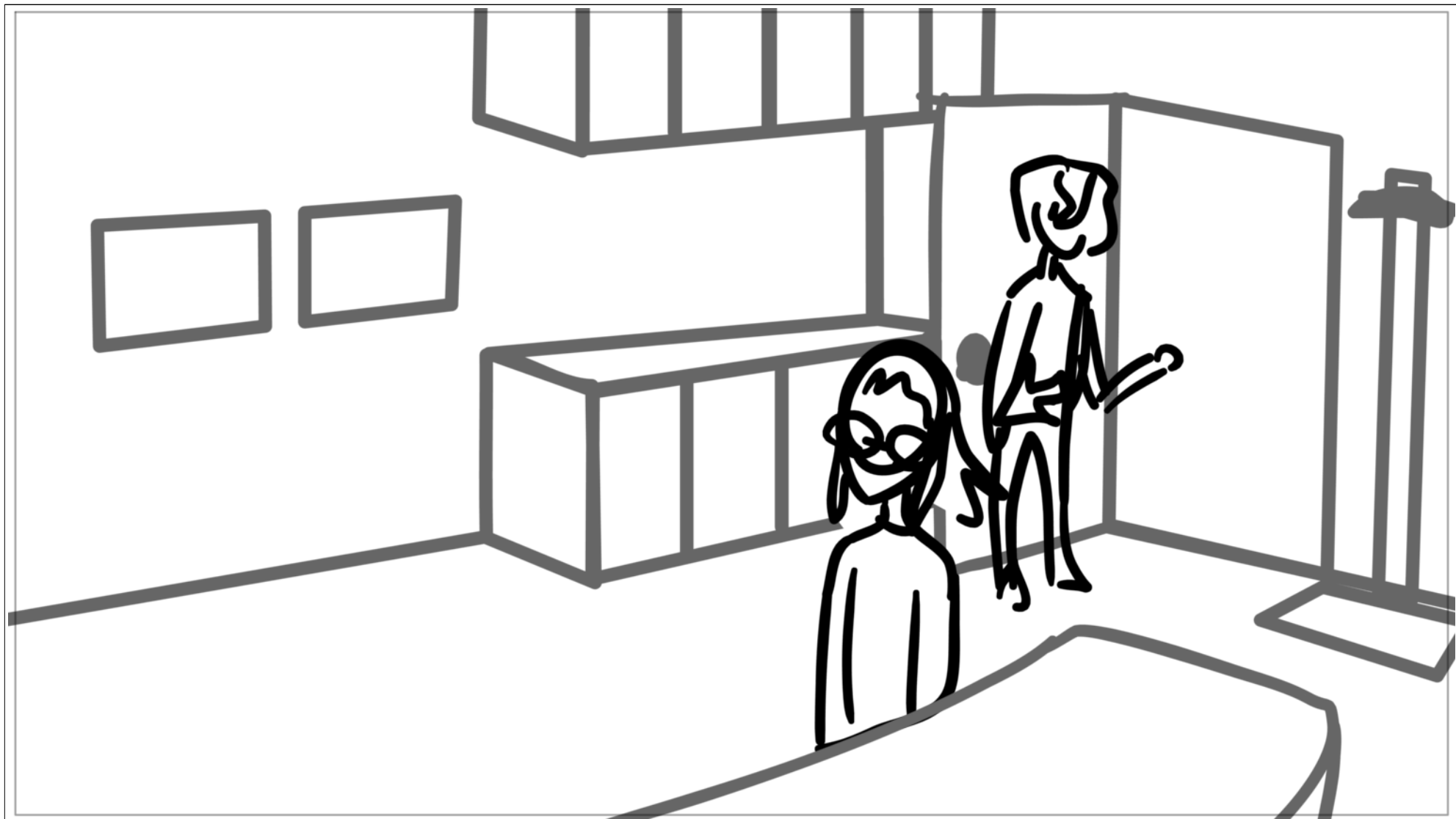

Scene	14_H_11_D_1	Duration	02:12	Panel	2	Duration	01:06
-------	-------------	----------	-------	-------	---	----------	-------

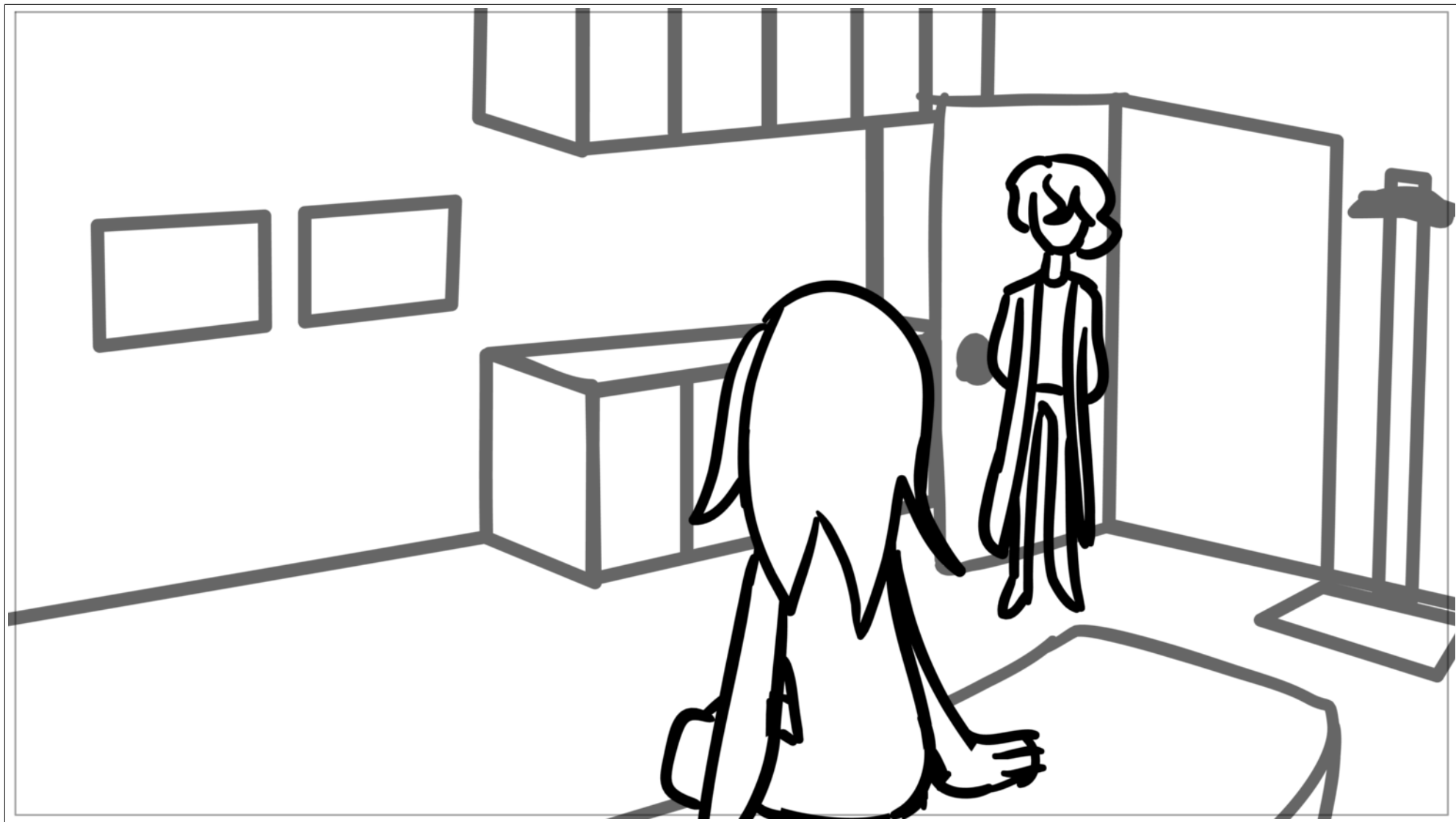

Scene	14_H_11_D_2	Duration	03:13	Panel	1	Duration	01:00
-------	-------------	----------	-------	-------	---	----------	-------



Scene	14_H_11_D_2	Duration	03:13	Panel	2	Duration	00:16
-------	-------------	----------	-------	-------	---	----------	-------



Scene	14_H_11_D_2	Duration	03:13	Panel	3	Duration	00:21
-------	-------------	----------	-------	-------	---	----------	-------



Scene	14_H_11_D_2	Duration	03:13	Panel	4	Duration	01:00
-------	-------------	----------	-------	-------	---	----------	-------



Scene	Duration	Panel	Duration
14_H_11_D_3	02:14	1	00:15

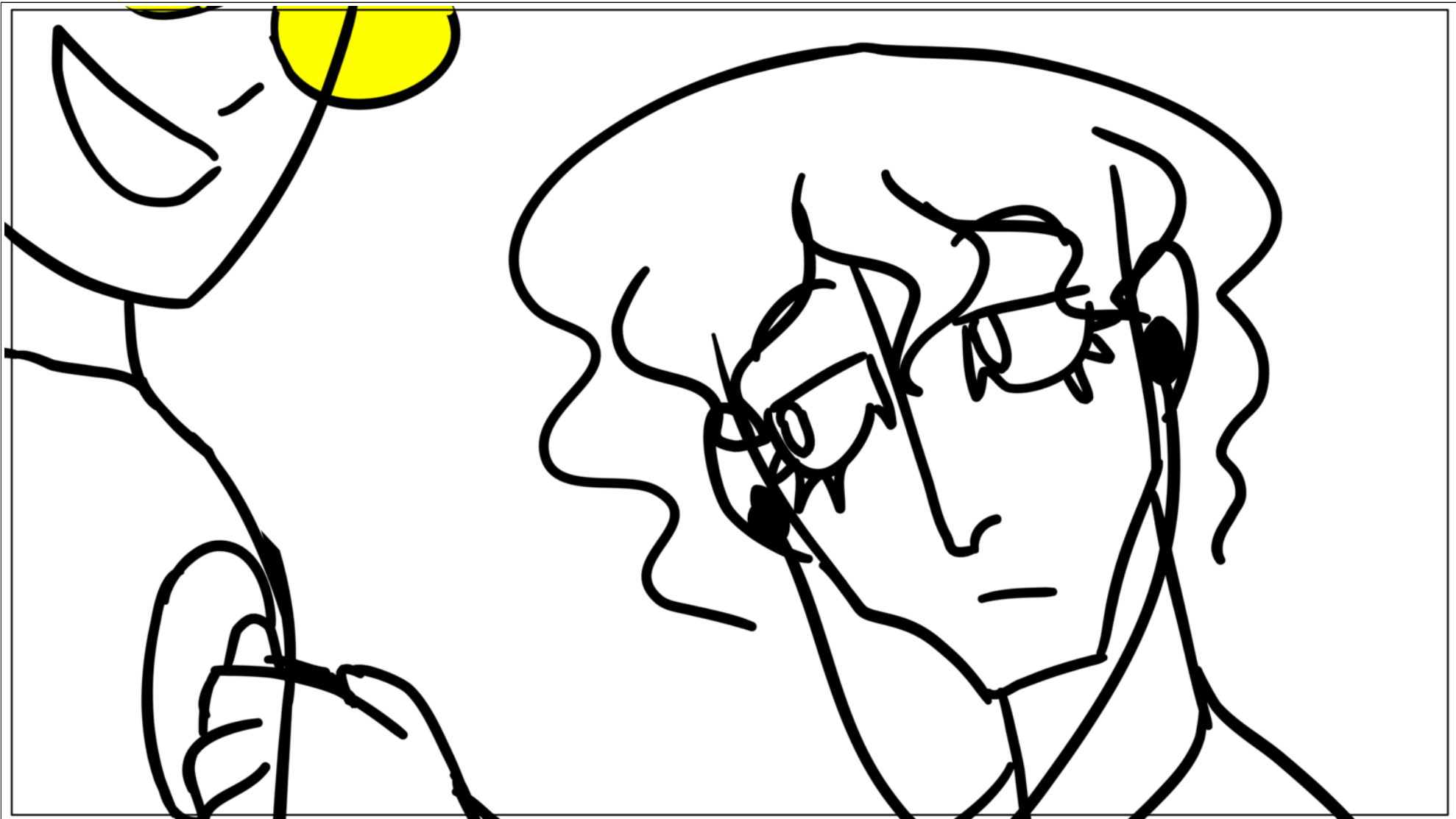

Scene	Duration	Panel	Duration
14_H_11_D_3	02:14	2	00:15

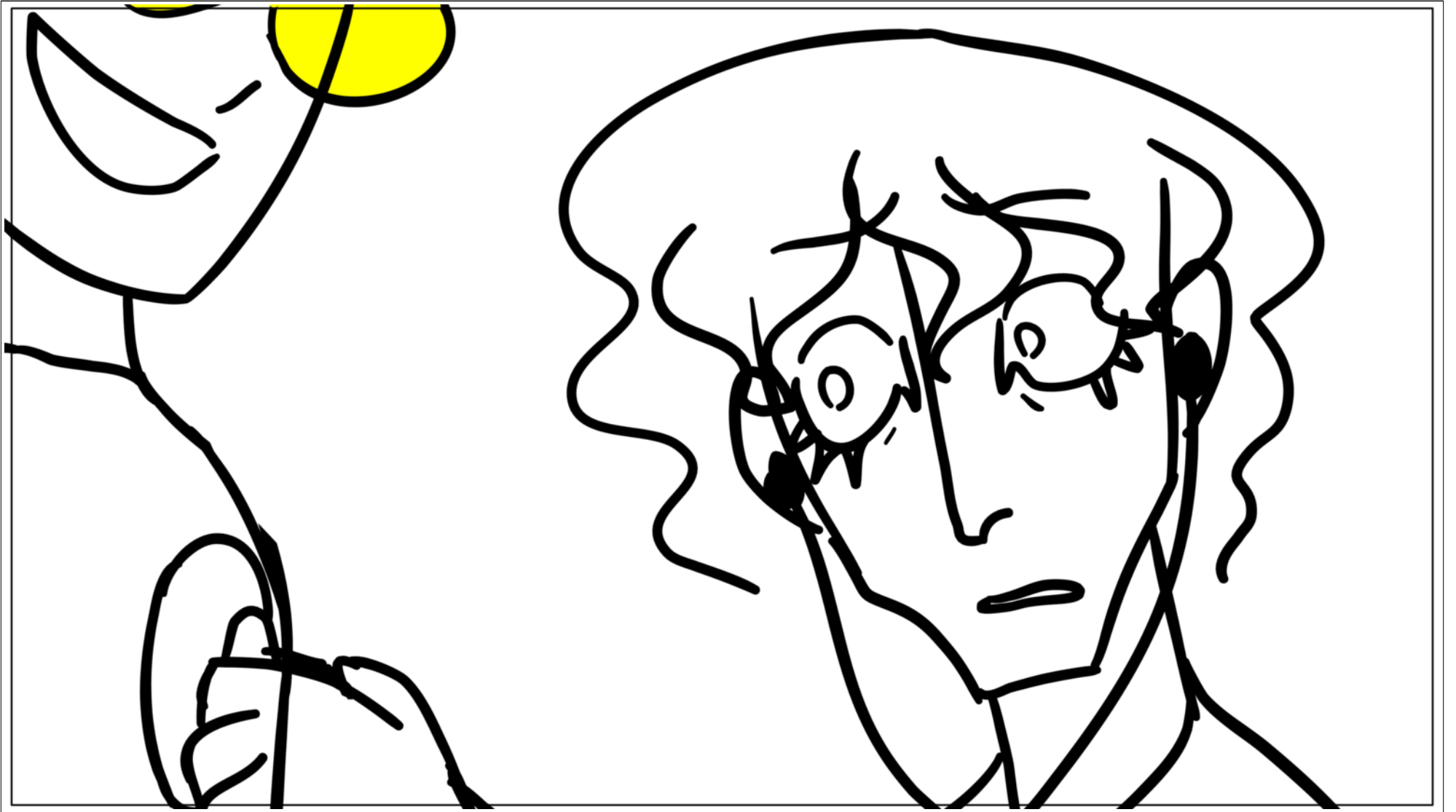

Scene	14_H_11_D_3	Duration	02:14	Panel	3	Duration	01:08
-------	-------------	----------	-------	-------	---	----------	-------

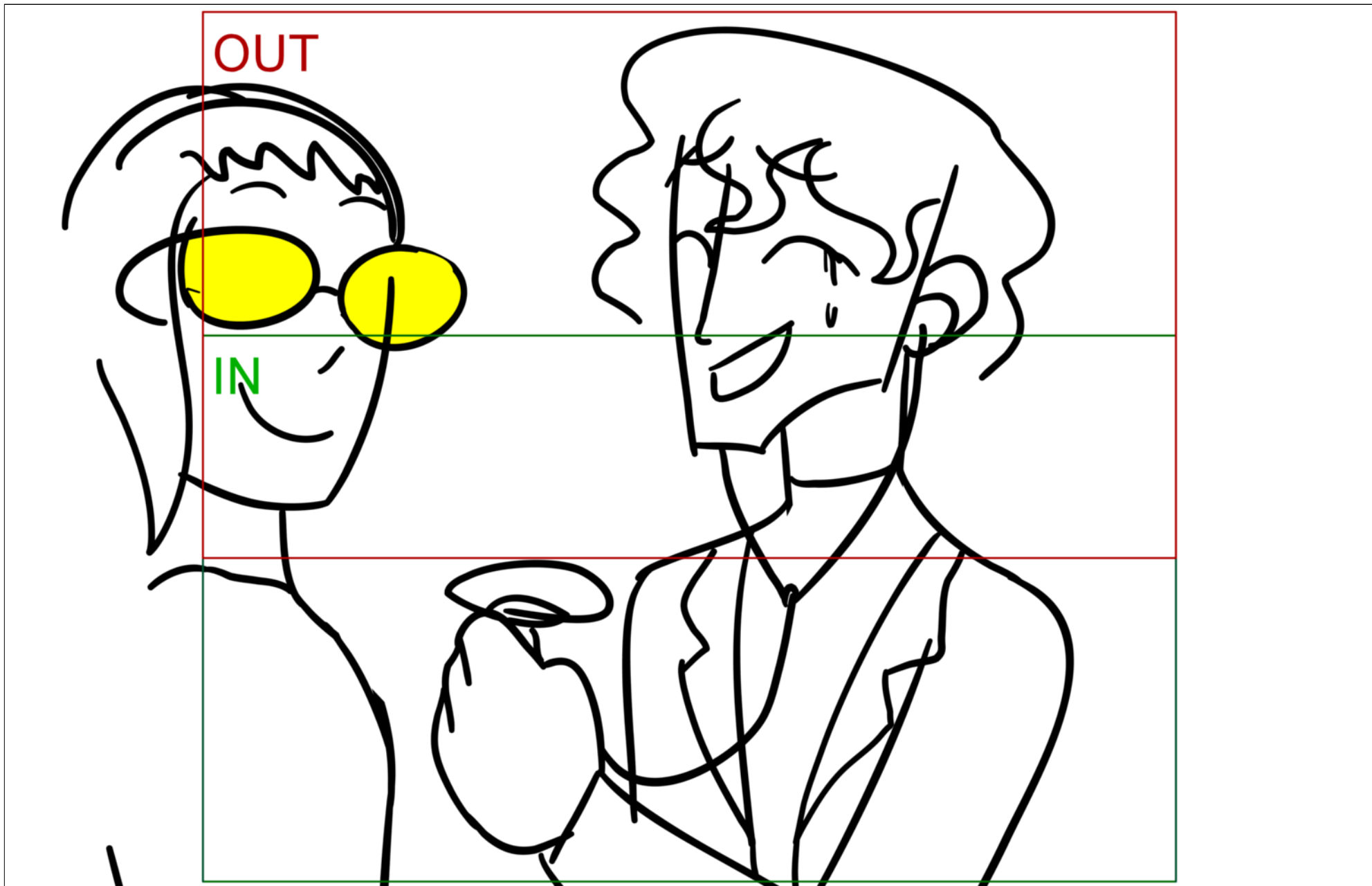

Scene	Duration	Panel	Duration
14_H_11_D_4	03:00	1	01:03

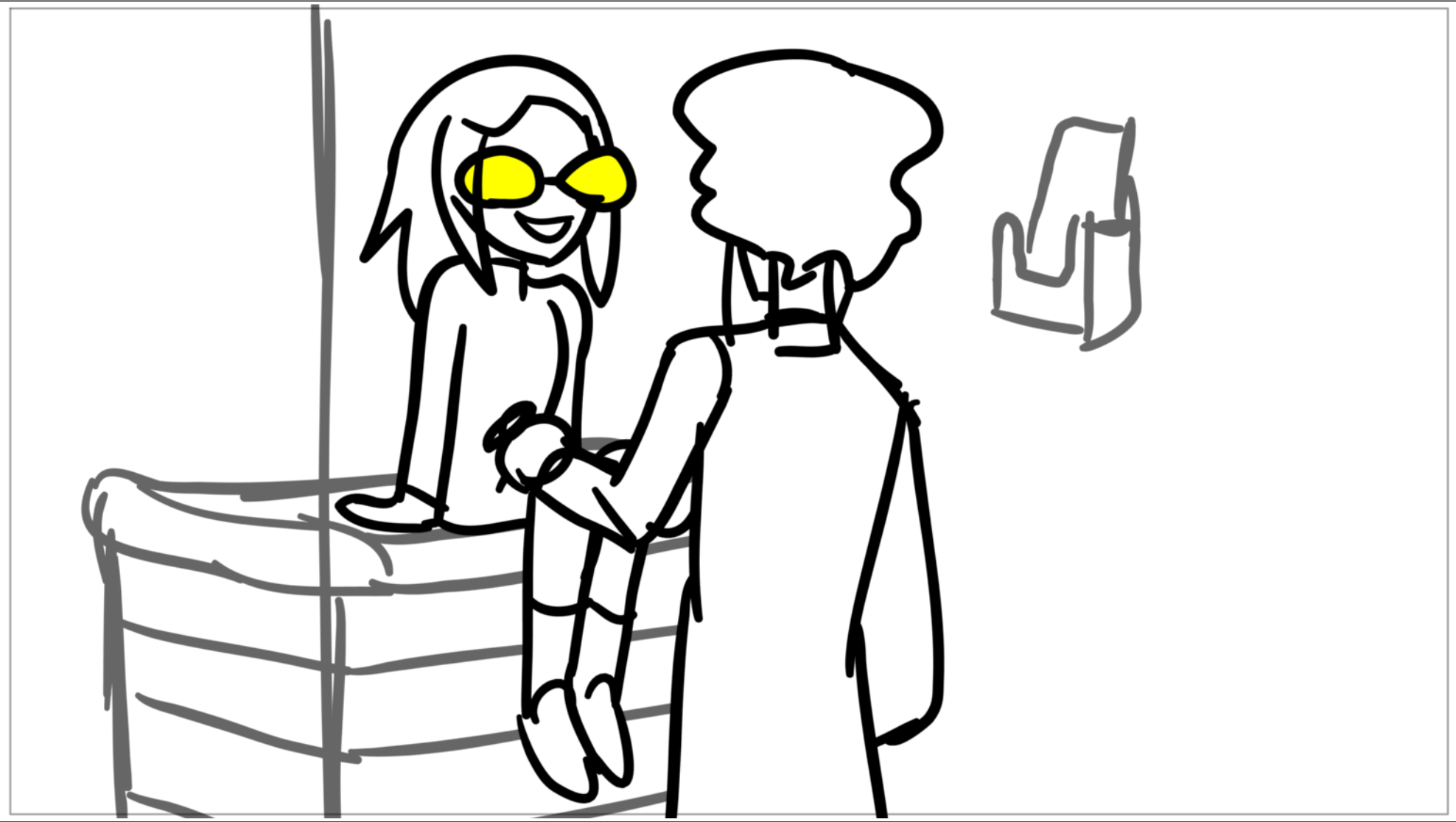

Scene	Duration	Panel	Duration
14_H_11_D_4	03:00	2	01:00

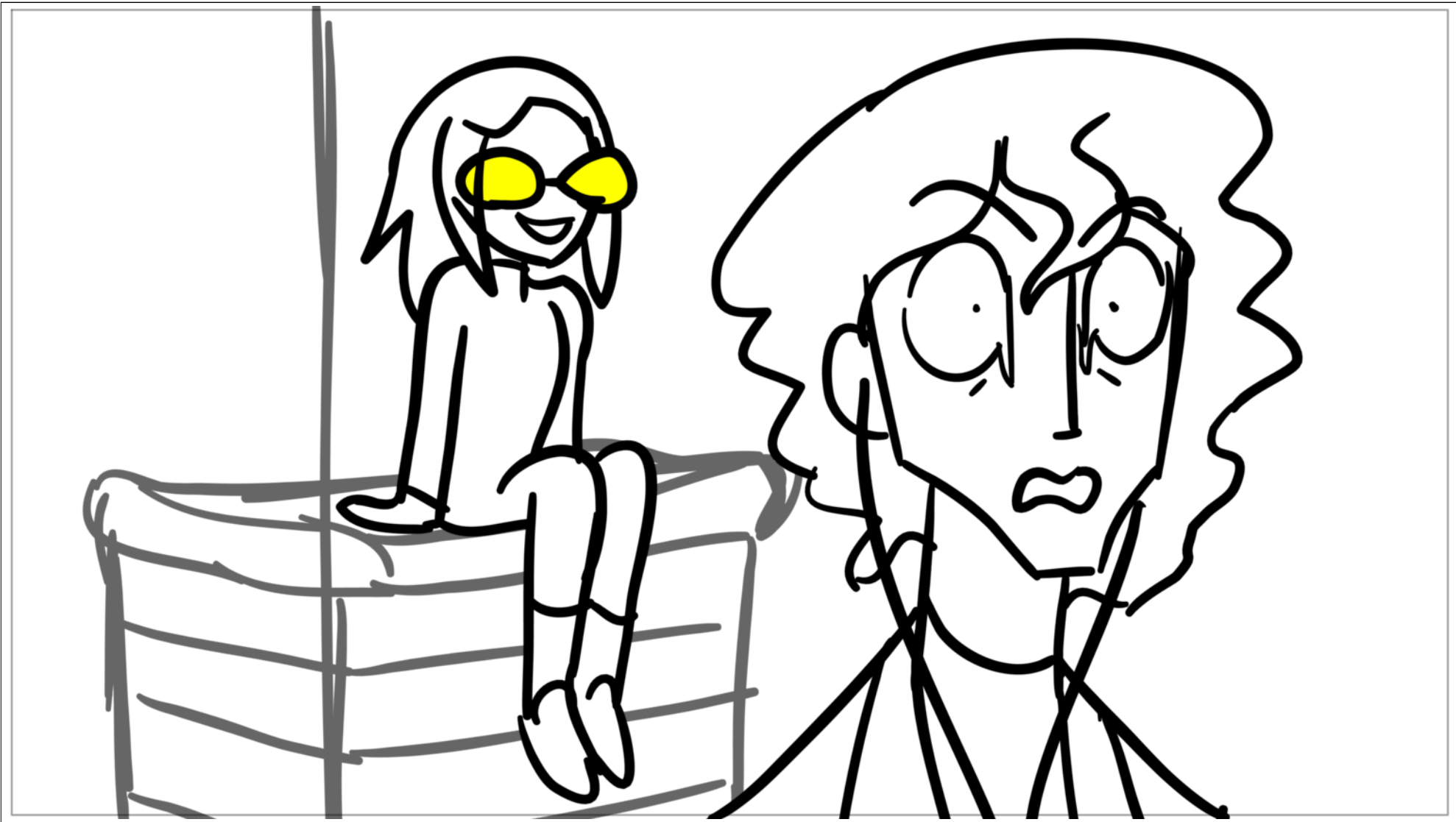

Scene	Duration	Panel	Duration
14_H_11_D_4	03:00	3	00:21



Scene	14_H_11_D_5	Duration	03:01	Panel	1	Duration	00:16
-------	-------------	----------	-------	-------	---	----------	-------

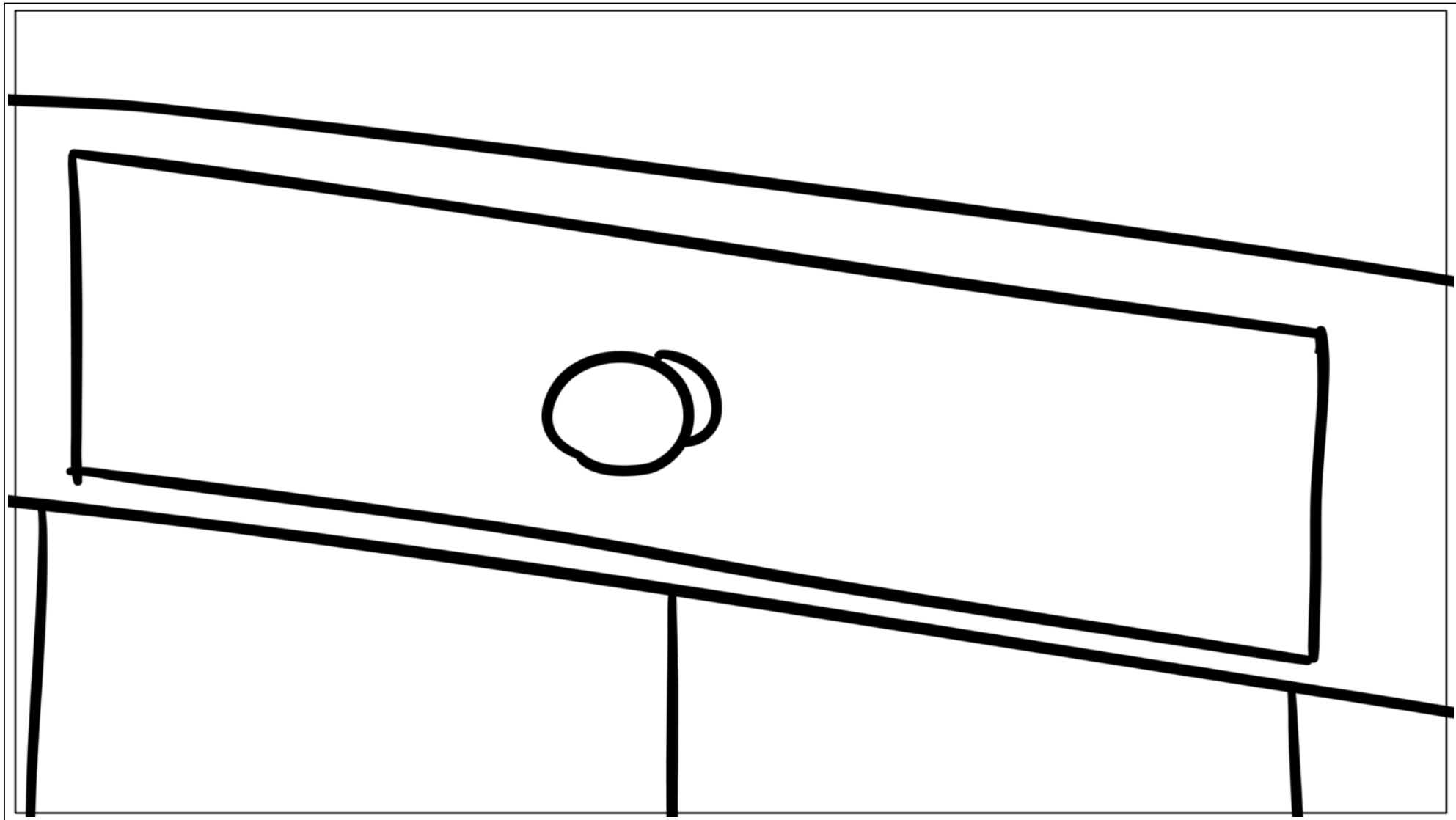

Scene	14_H_11_D_5	Duration	03:01	Panel	2	Duration	01:00
-------	-------------	----------	-------	-------	---	----------	-------

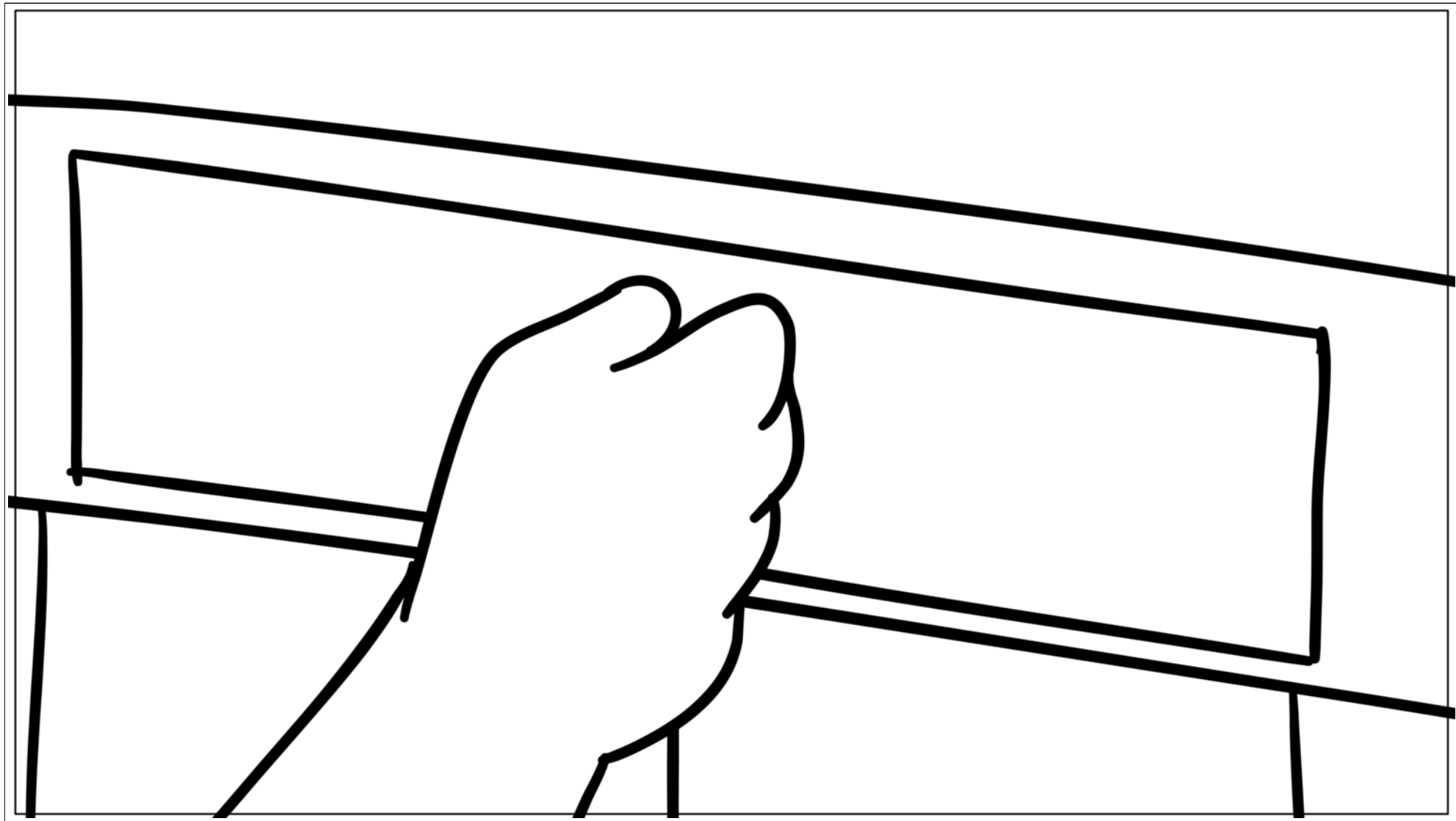

Scene	14_H_11_D_5	Duration	03:01	Panel	3	Duration	01:09
-------	-------------	----------	-------	-------	---	----------	-------

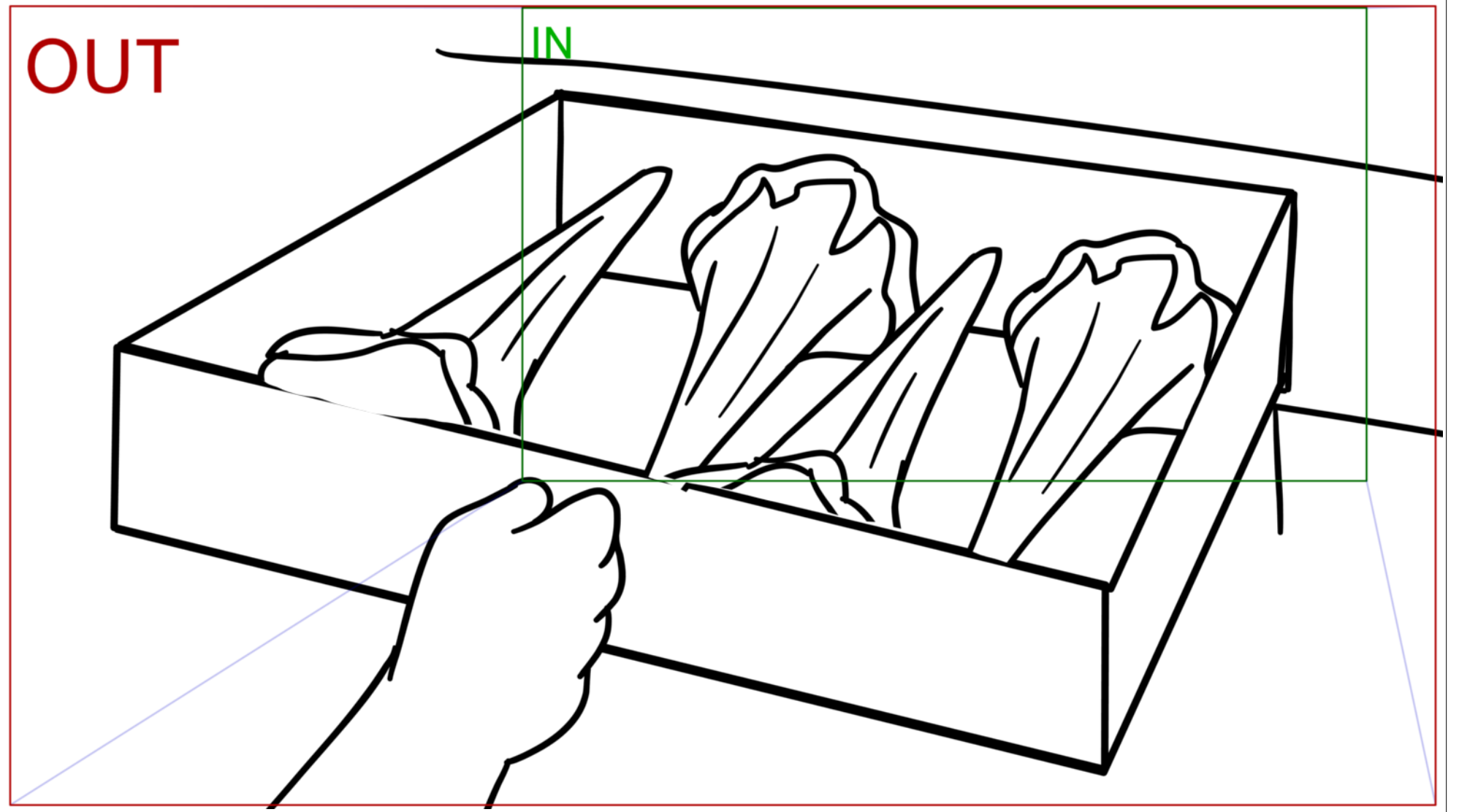

Scene	Duration	Panel	Duration
14_H_11_D_4_A	02:12	1	01:12

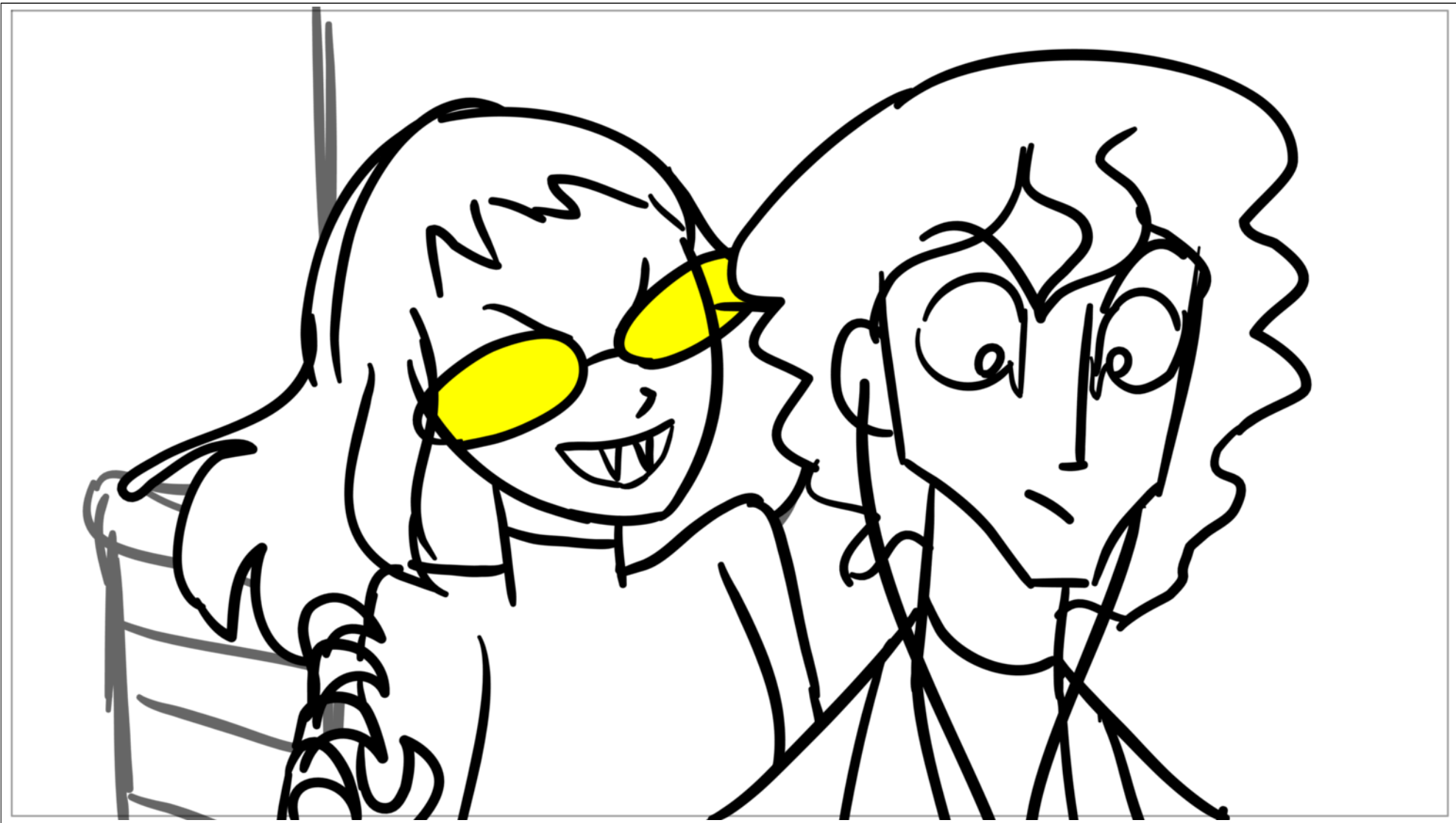

Scene	Duration	Panel	Duration
14_H_11_D_4_A	02:12	2	01:00



Scene	14_H_11_D_4_B	Duration	02:17	Panel	1	Duration	00:17
-------	---------------	----------	-------	-------	---	----------	-------

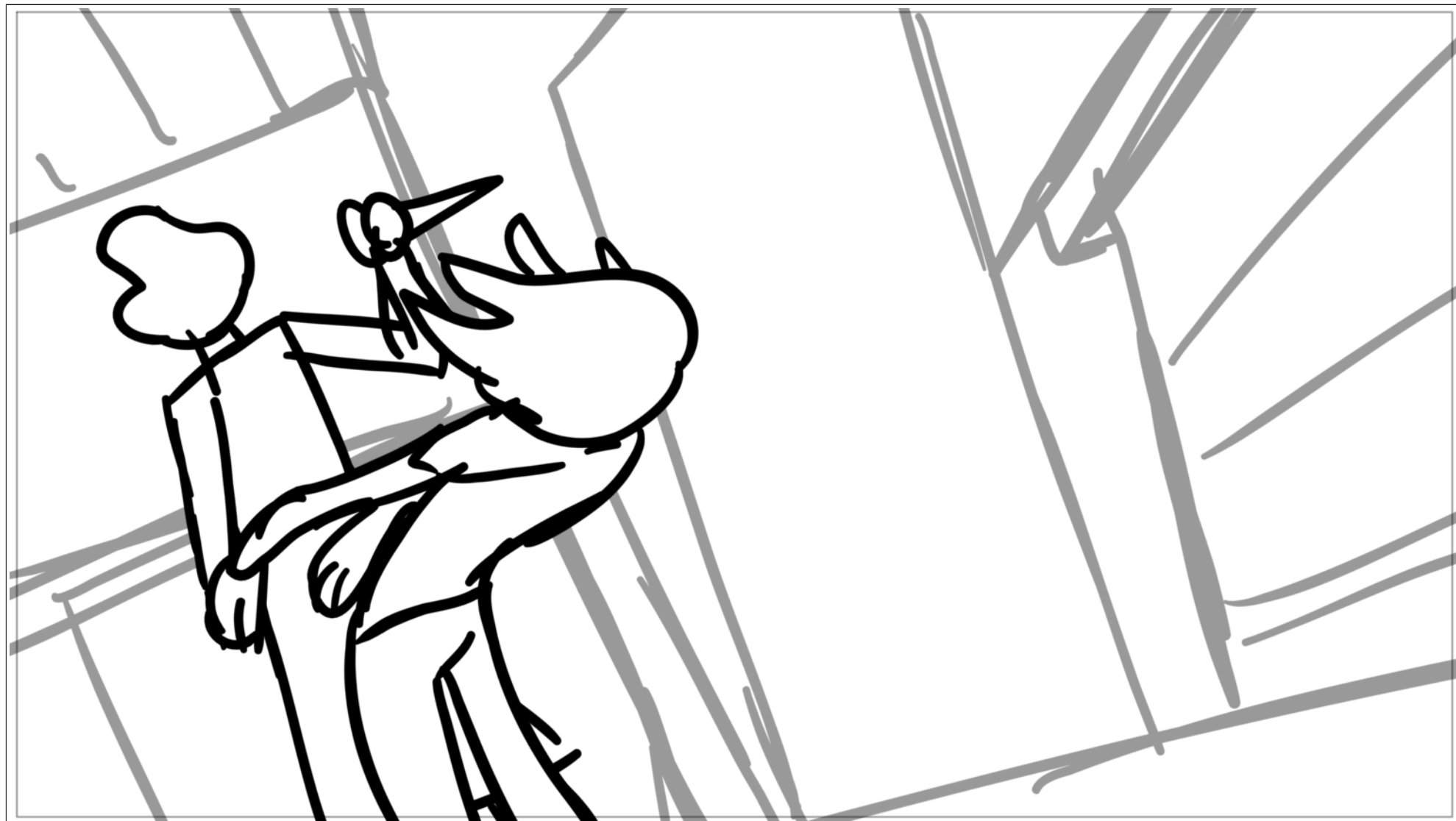

Scene	14_H_11_D_4_B	Duration	02:17	Panel	2	Duration	01:00
-------	---------------	----------	-------	-------	---	----------	-------

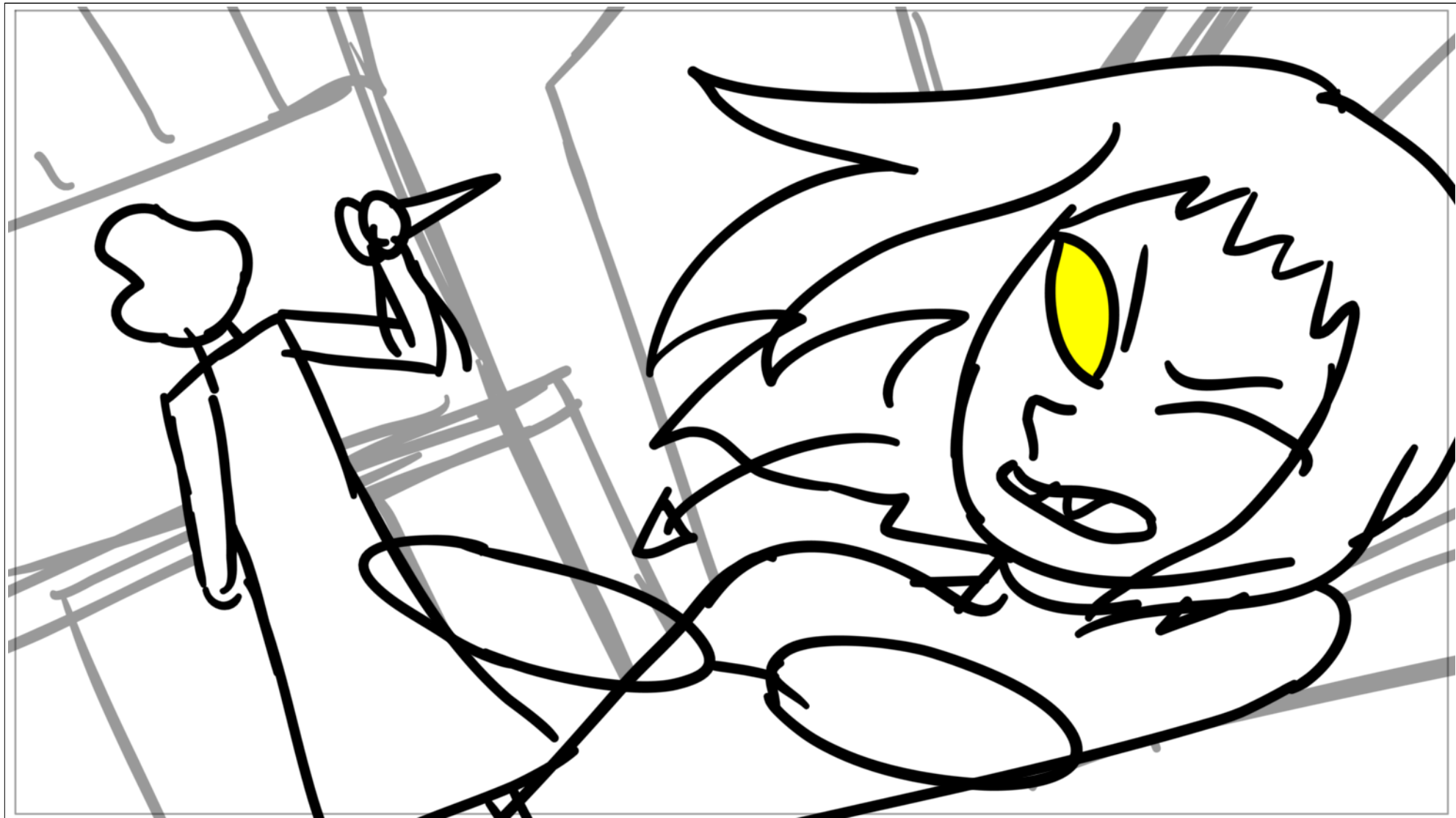

Scene	14_H_11_D_4_B	Duration	02:17	Panel	3	Duration	01:00
-------	---------------	----------	-------	-------	---	----------	-------



Scene	Duration	Panel	Duration
14_H_11_D_4_C	01:13	1	01:13



Scene	14_H_11_D_4_D	Duration	01:20	Panel	1	Duration	00:18
-------	---------------	----------	-------	-------	---	----------	-------

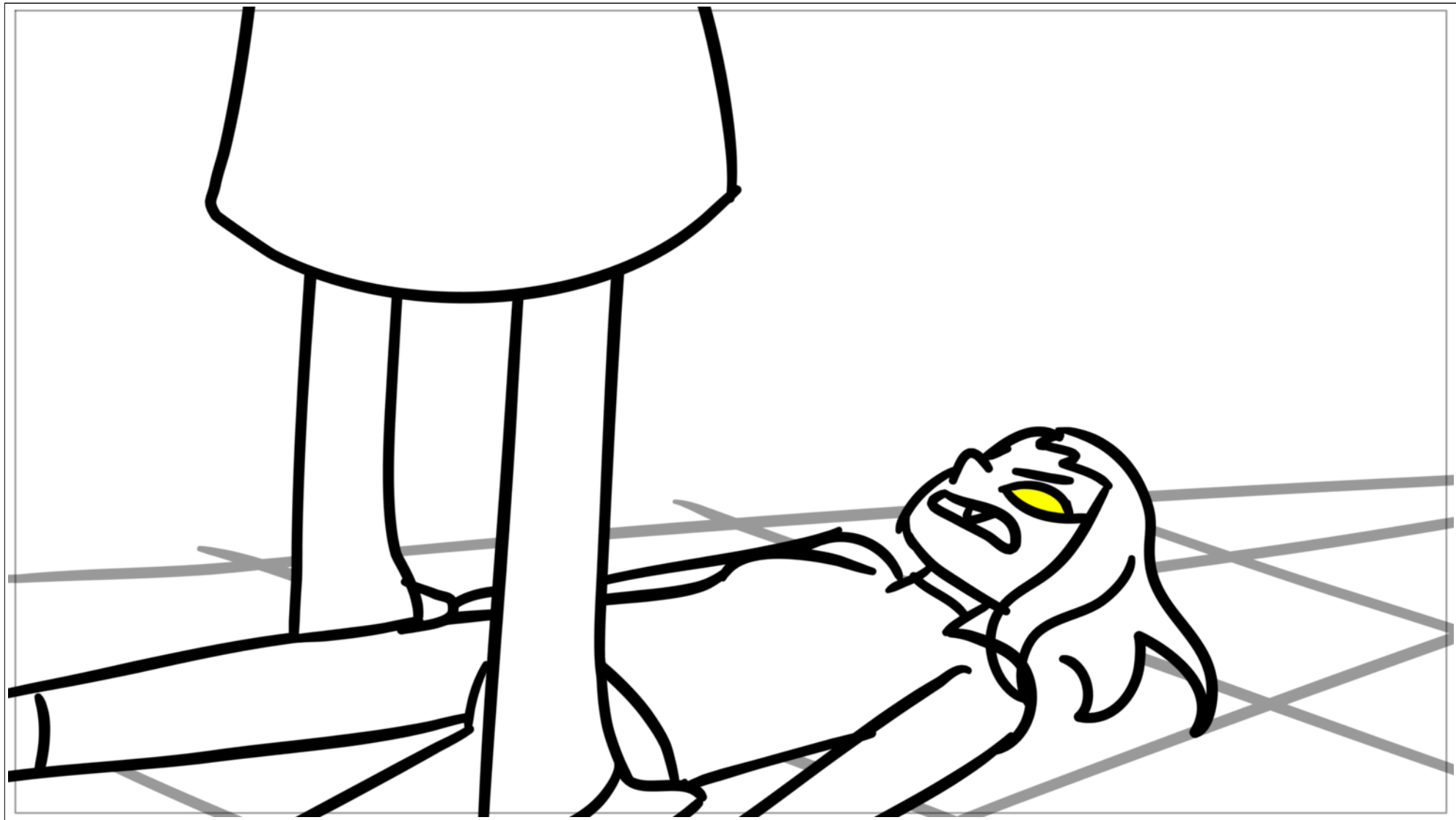

Scene	14_H_11_D_4_D	Duration	01:20	Panel	2	Duration	01:02
-------	---------------	----------	-------	-------	---	----------	-------



Scene	14_H_11_D_4_E	Duration	01:00	Panel	1	Duration	01:00
-------	---------------	----------	-------	-------	---	----------	-------



Scene	14_H_11_D_4_F	Duration	01:00	Panel	1	Duration	01:00
-------	---------------	----------	-------	-------	---	----------	-------

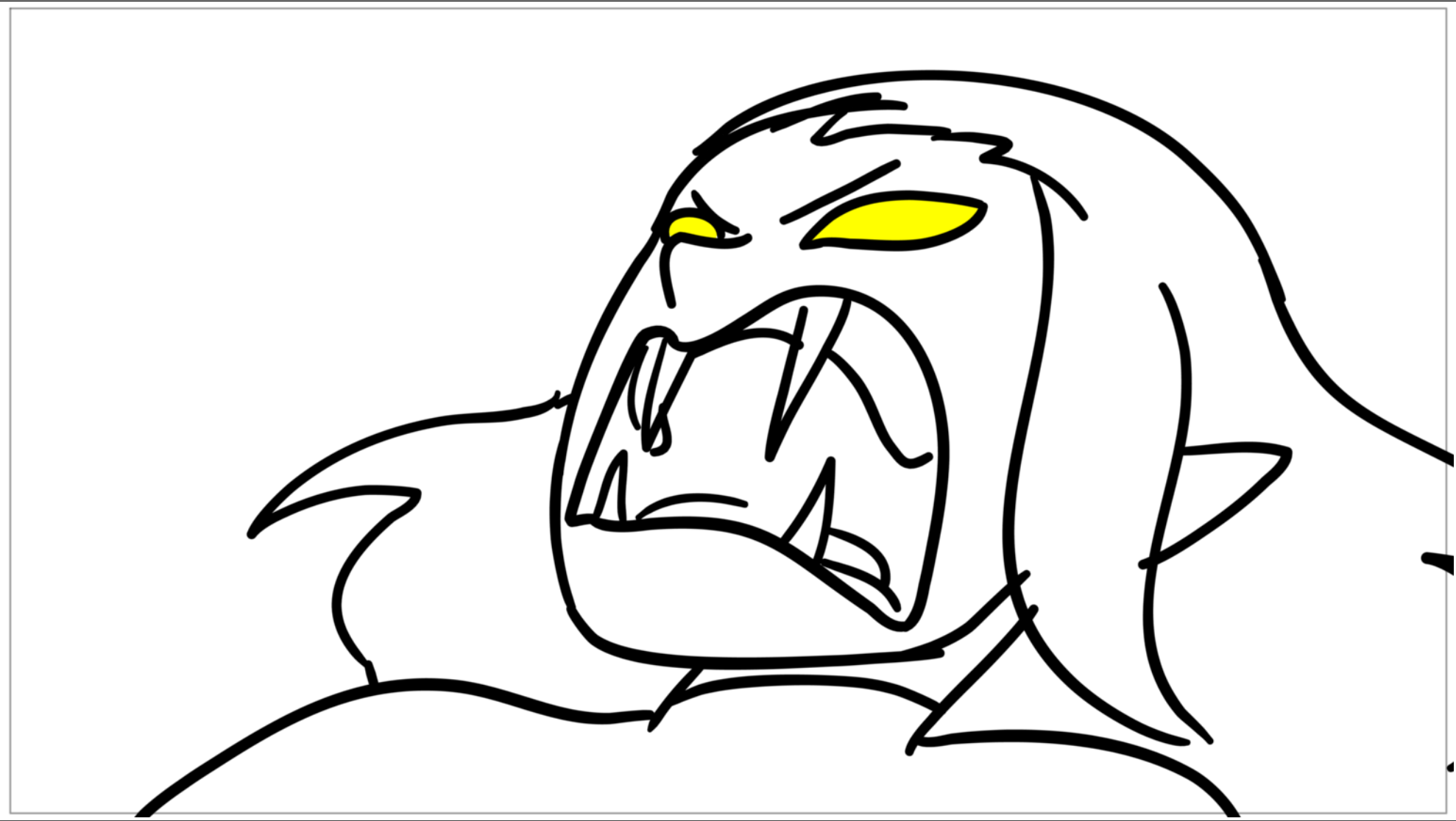

Scene	Duration	Panel	Duration
14_H_11_D_4_G	02:01	1	01:09

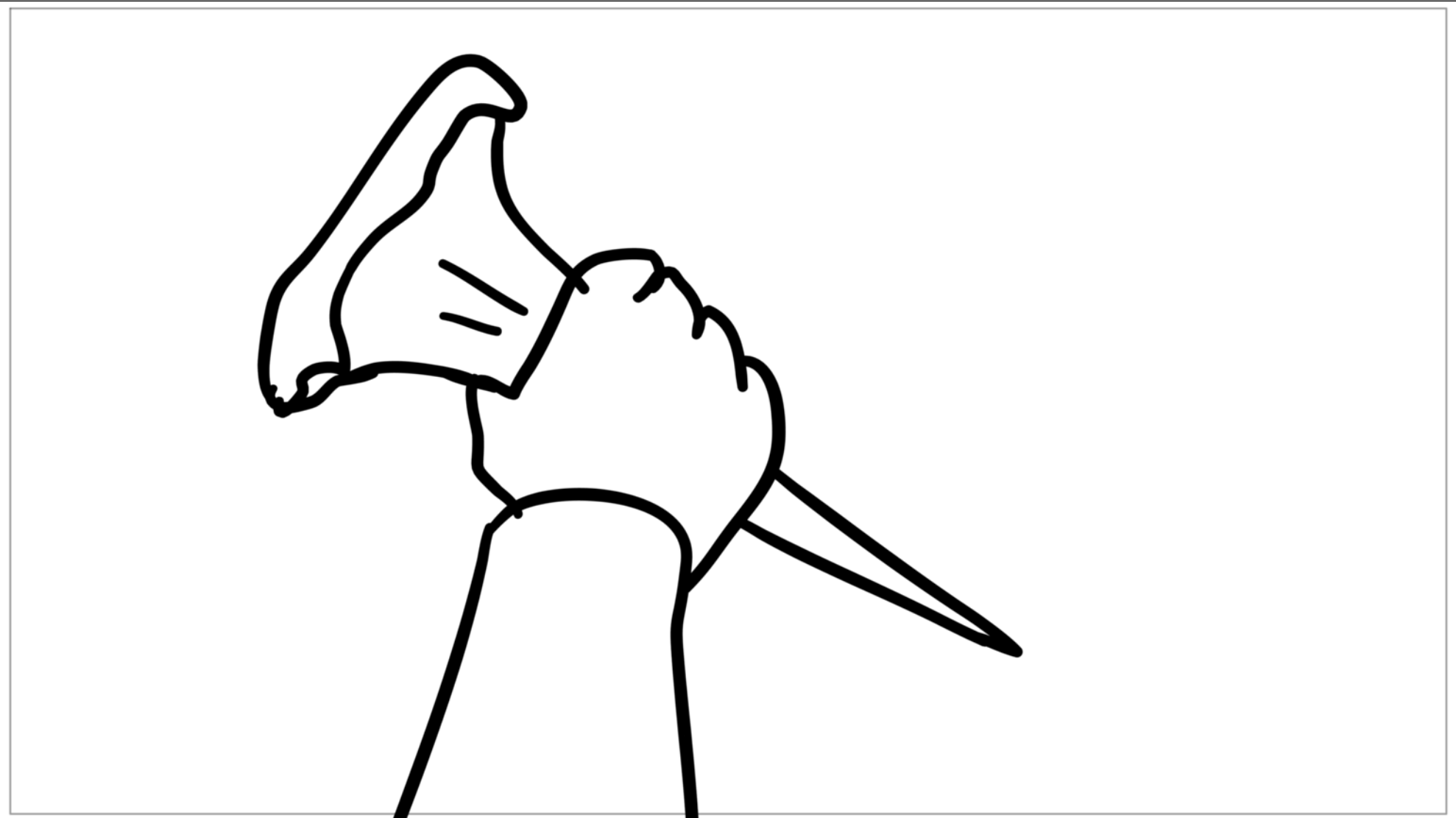

Scene	14_H_11_D_4_G	Duration	02:01	Panel	2	Duration	00:05
-------	---------------	----------	-------	-------	---	----------	-------

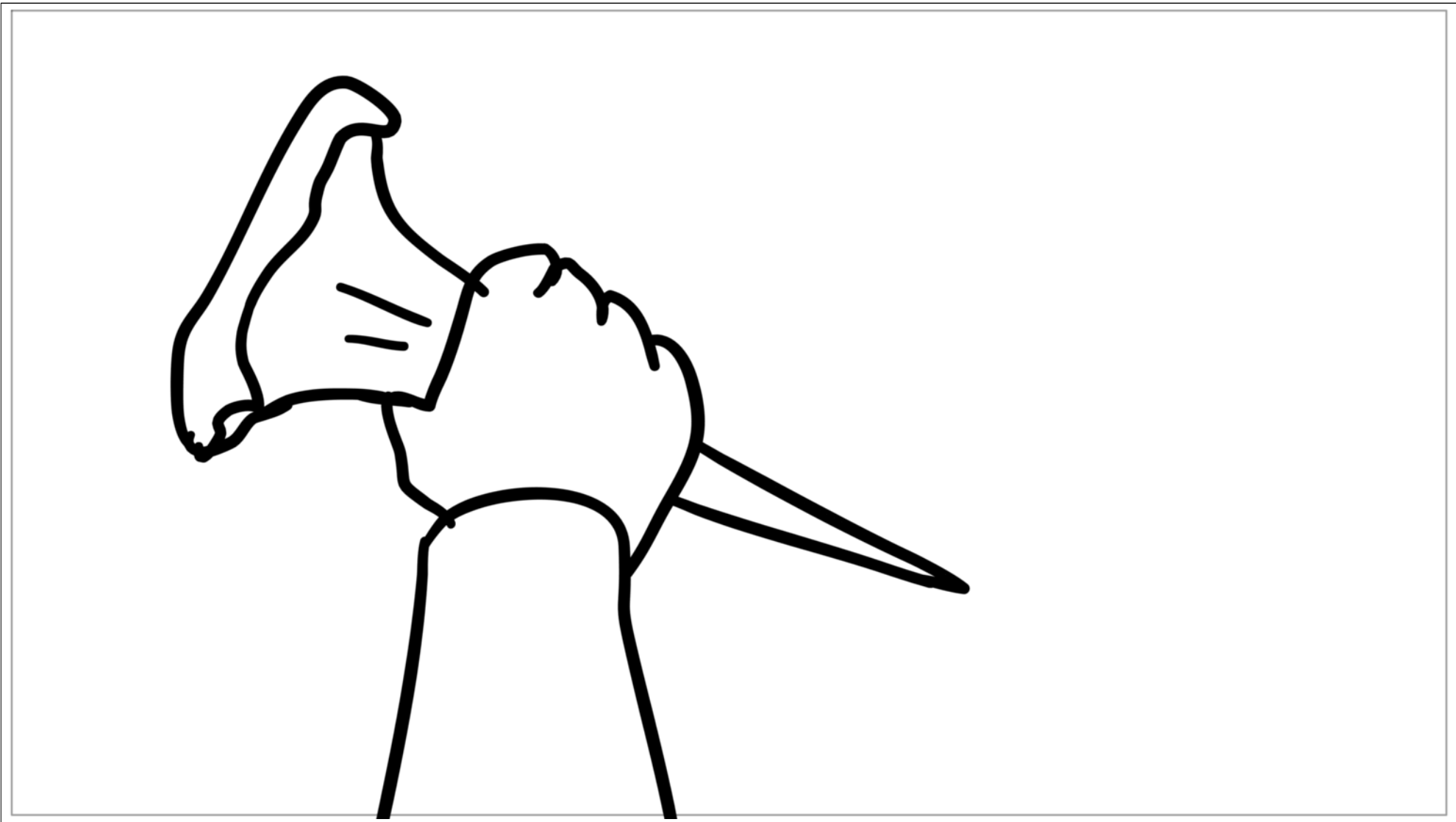

Scene	Duration	Panel	Duration
14_H_11_D_4_G	02:01	3	00:11

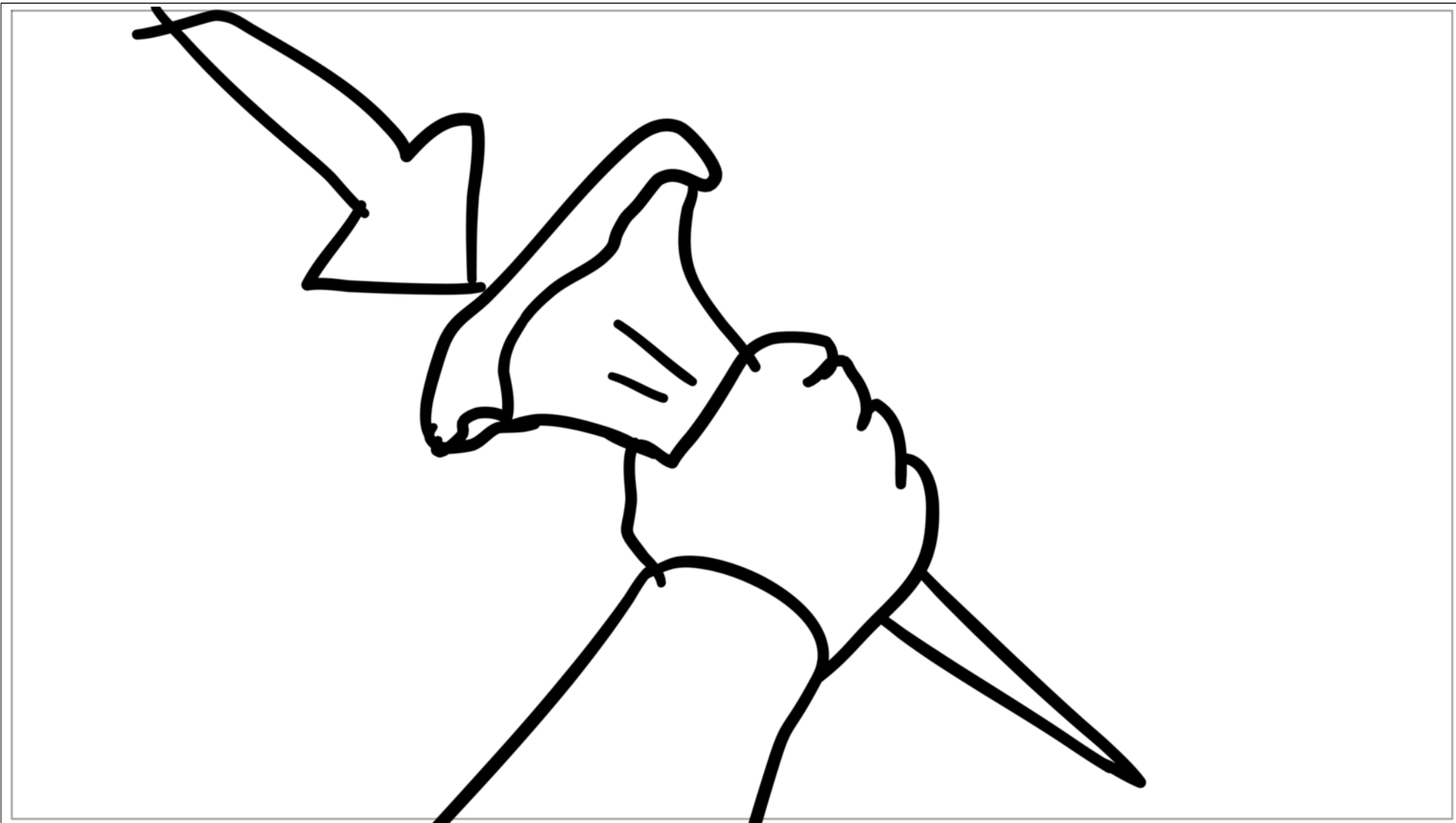

Scene	Duration	Panel	Duration
14_H_11_D_4_H	01:14	1	00:04

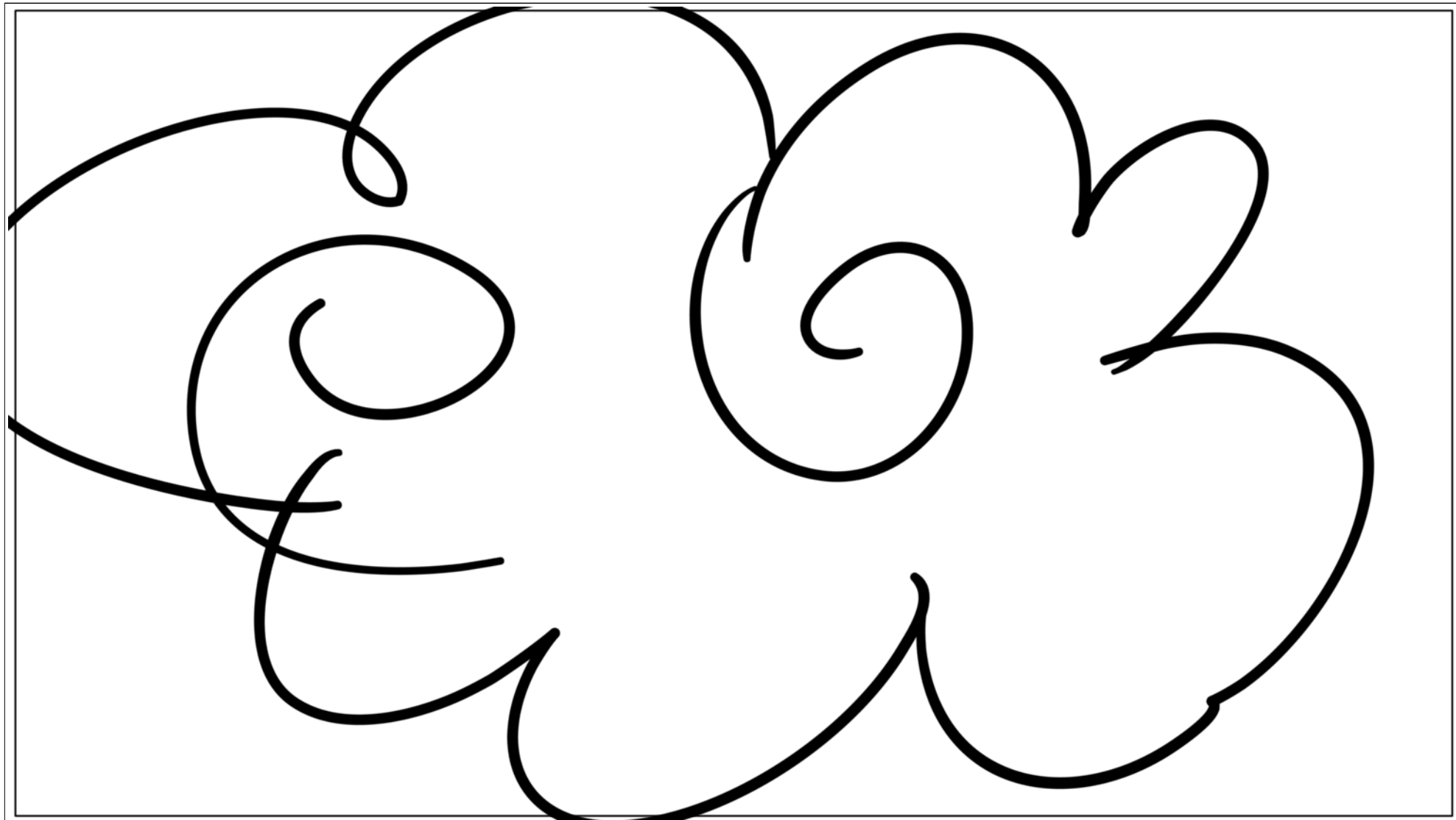

Scene	14_H_11_D_4_H	Duration	01:14	Panel	2	Duration	01:10
-------	---------------	----------	-------	-------	---	----------	-------

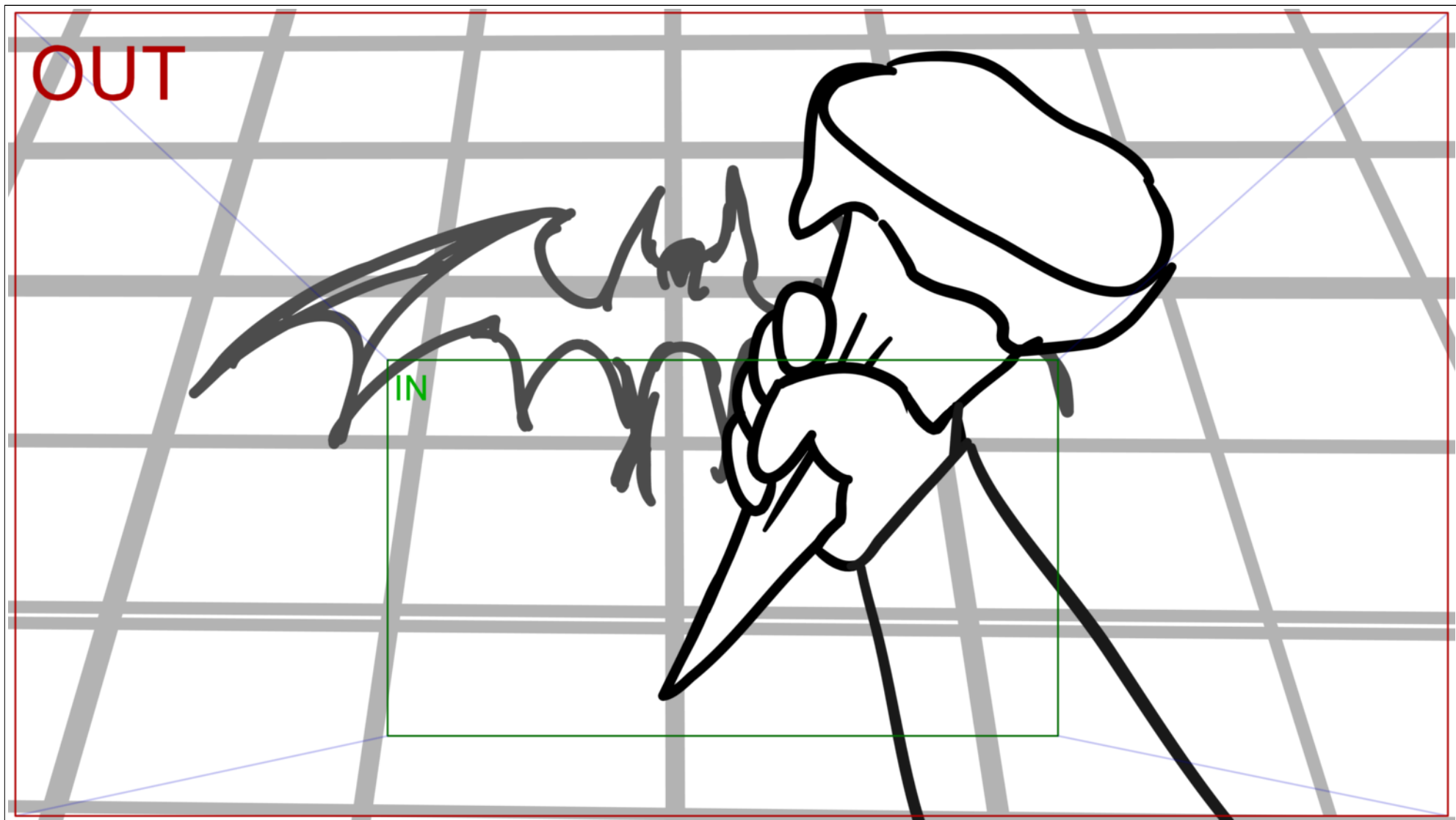

Scene	14_H_11_D_4_I	Duration	01:22	Panel	1	Duration	00:21
-------	---------------	----------	-------	-------	---	----------	-------



Scene	14_H_11_D_4_I	Duration	01:22	Panel	2	Duration	01:01
-------	---------------	----------	-------	-------	---	----------	-------



Scene	14_H_11_D_4_J	Duration	02:00	Panel	1	Duration	00:19
-------	---------------	----------	-------	-------	---	----------	-------



Scene	14_H_11_D_4_J	Duration	02:00	Panel	2	Duration	00:19
-------	---------------	----------	-------	-------	---	----------	-------



Scene	14_H_11_D_4_J	Duration	02:00	Panel	3	Duration	00:10
-------	---------------	----------	-------	-------	---	----------	-------



Scene	Duration	Panel	Duration
14_H_11_D_4_J_1_0	01:00	1	01:00

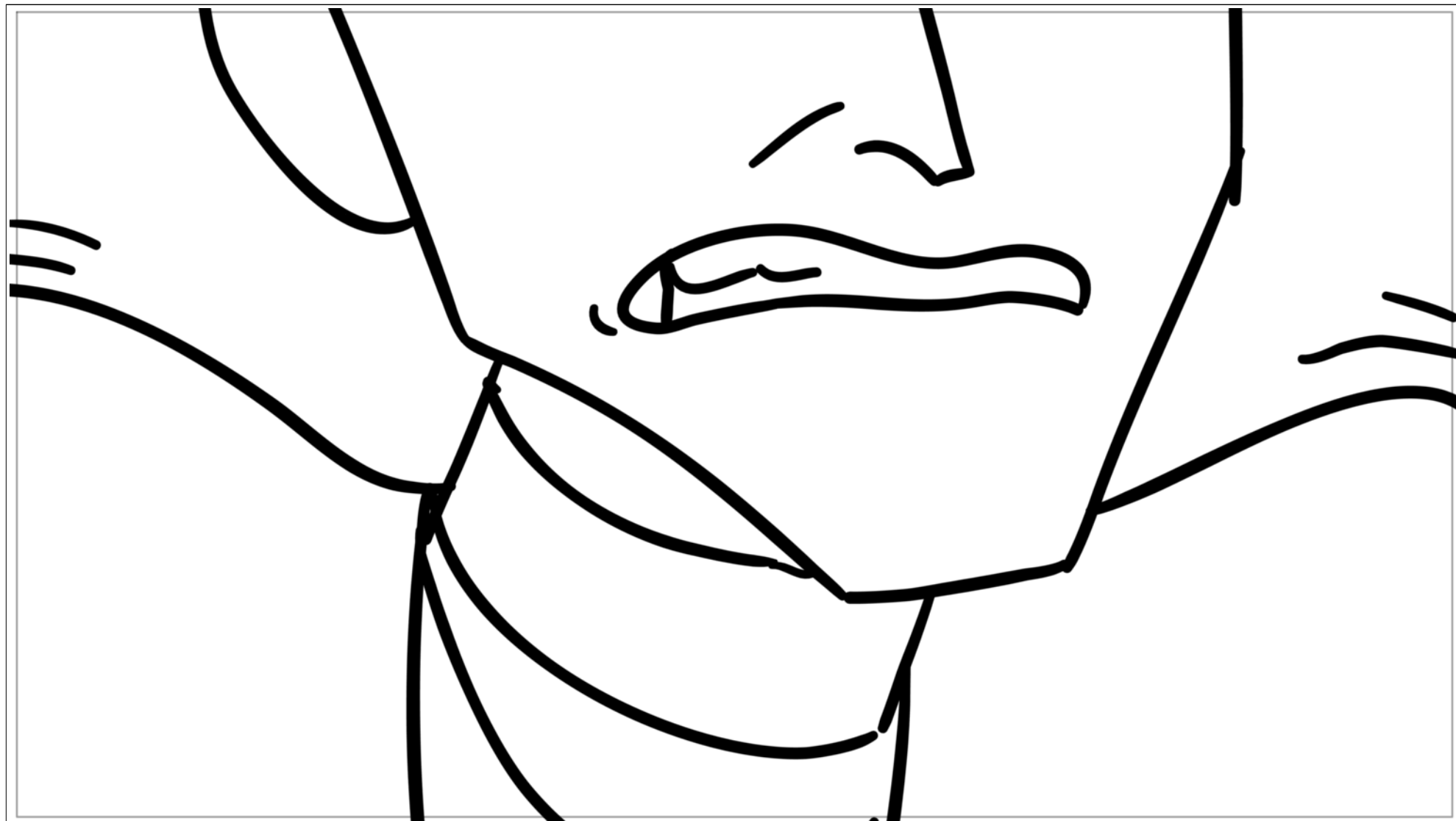

Scene	Duration	Panel	Duration
14_H_11_D_4_J_1_1	01:00	1	01:00

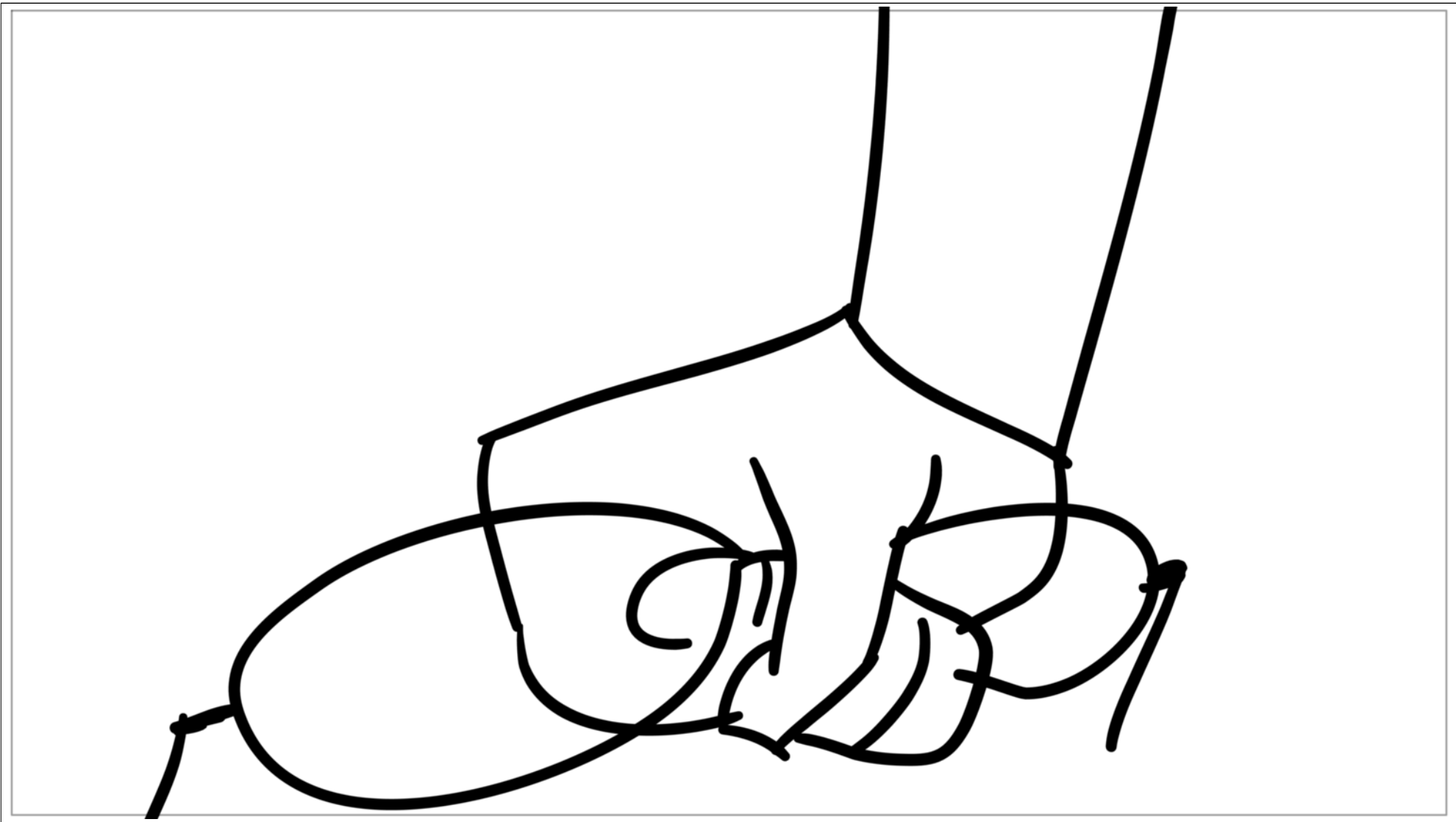

Scene	Duration	Panel	Duration
14_H_11_D_4_J_1_2	03:00	1	01:00



Scene	Duration	Panel	Duration
14_H_11_D_4_J_1_2	03:00	2	01:00



Scene	Duration	Panel	Duration
14_H_11_D_4_J_1_2	03:00	3	01:00

